

2018 | 2019

FREE

ACT[®]

Preparing for the ACT[®] Test

What's Inside

- Full-Length Practice ACT Test, including the Optional Writing Test
- Information about the Multiple-Choice and Writing Tests
- Test-Taking Strategies
- What to Expect on Test Day

Esta publicación también se puede ver o descargar en español en www.actstudent.org

The **ACT**[®]

www.actstudent.org



Practice Multiple-Choice Tests

EXAMINEE STATEMENT, CERTIFICATION, AND SIGNATURE

1. Read the following **Statement**: By opening this test booklet, I agree to comply with and be bound by the *Terms and Conditions: Testing Rules and Policies for the ACT® Test* provided in the ACT registration materials for this test, including those concerning test security, score cancellation, examinee remedies, binding arbitration, and consent to the processing of my personally identifying information, including the collection, use, transfer, and disclosure of information as described in the ACT Privacy Policy (www.act.org/privacy.html).

I understand that ACT owns the test questions and responses and affirm that I will not share any test questions or responses with anyone by any form of communication before, during, or after the test administration. I understand that assuming anyone else's identity to take this test is strictly prohibited and may violate the law and subject me to legal penalties.

International Examinees: By my signature, I am also providing my consent to ACT to transfer my personally identifying information to the United States to ACT, or a third-party service provider for processing, where it will be subject to use and disclosure under the laws of the United States. I acknowledge and agree that it may also be accessible to law enforcement and national security authorities in the United States.

2. Copy the **Certification** shown below (only the text in italics) on the lines provided. Write in your normal handwriting.

Certification: *I agree to the Statement above and certify that I am the person whose name appears on this form.*

3. Sign your name as you would any official document, enter today's date, and print your name in the spaces provided.

Your Signature

Today's Date

Print Your Name

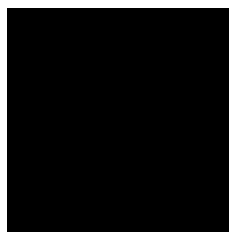

The **ACT**[®]

Form 1874FPRE

Directions

This booklet contains tests in English, mathematics, reading, and science. These tests measure skills and abilities highly related to high school course work and success in college. **Calculators may be used on the mathematics test only.**

The questions in each test are numbered, and the suggested answers for each question are lettered. On the answer document, the rows of ovals are numbered to match the questions, and the ovals in each row are lettered to correspond to the suggested answers.

For each question, first decide which answer is best. Next, locate on the answer document the row of ovals numbered the same as the question. Then, locate the oval in that row lettered the same as your answer. Finally, fill in the oval completely. Use a soft lead pencil and make your marks heavy and black. **Do not use ink or a mechanical pencil.**

Mark only one answer to each question. If you change your mind about an answer, erase your first mark thoroughly before marking your new answer. For each question, make certain that you mark in the row of ovals with the same number as the question.

Only responses marked on your answer document will be scored. Your score on each test will be based only on the number of questions you answer correctly during the time allowed for that test. You will **not** be penalized for guessing. **It is to your advantage to answer every question even if you must guess.**

You may work on each test **only** when the testing staff tells you to do so. If you finish a test before time is called for that test, you should use the time remaining to reconsider questions you are uncertain about in that test. You may **not** look back to a test on which time has already been called, and you may **not** go ahead to another test. To do so will disqualify you from the examination.

Lay your pencil down immediately when time is called at the end of each test. You may **not** for any reason fill in or alter ovals for a test after time is called for that test. To do so will disqualify you from the examination.

Do not fold or tear the pages of your test booklet.

**DO NOT OPEN THIS BOOKLET
UNTIL TOLD TO DO SO.**



ENGLISH TEST

45 Minutes—75 Questions

DIRECTIONS: In the five passages that follow, certain words and phrases are underlined and numbered. In the right-hand column, you will find alternatives for the underlined part. In most cases, you are to choose the one that best expresses the idea, makes the statement appropriate for standard written English, or is worded most consistently with the style and tone of the passage as a whole. If you think the original version is best, choose “NO CHANGE.” In some cases, you will find in the right-hand column a question about the underlined part. You are to choose the best answer to the question.

You will also find questions about a section of the passage, or about the passage as a whole. These questions do not refer to an underlined portion of the passage, but rather are identified by a number or numbers in a box.

For each question, choose the alternative you consider best and fill in the corresponding oval on your answer document. Read each passage through once before you begin to answer the questions that accompany it. For many of the questions, you must read several sentences beyond the question to determine the answer. Be sure that you have read far enough ahead each time you choose an alternative.

PASSAGE I

Mystery Paper Sculptor

Between March and November of 2011, an anonymous donor left intricately¹ crafted paper sculptures at various cultural institutions in Edinburgh, Scotland.

Delighted, each sculpture was left secretly and was later discovered² by staff. The delicate sculptures—streetscapes, plants, and animals—were carved exclusively from the pages and bindings of books. The tiny details in the pieces are awe-inspiring.

The first sculpture discovered—at the Scottish Poetry Library—was a tiny tree formed from a book of verse. Library staff dubbed³ it the “poetree.” The tree sits atop a book. Beneath the tree are the halves of a golden paper egg, each half filled with words clipped from the poem “A Trace of Wings” by Edwin Morgan.

1. Which choice most effectively emphasizes the complexity of the paper sculptures?
 - A. NO CHANGE
 - B. impressively
 - C. terrifically
 - D. superbly
2. F. NO CHANGE
 - G. Each sculpture was left secretly and later discovered by delighted staff.
 - H. Left secretly and later discovered by staff, each sculpture was delighted.
 - J. Secretly delighted, each sculpture was discovered by staff.
3. A. NO CHANGE
 - B. specified
 - C. adorned
 - D. honored

At Edinburgh’s Filmhouse Cinema, a three-
dimensional sculpted scene shows patrons

sitting in a movie theater as horse leaps out of
the screen. At the Scottish Storytelling Centre, a

dragon crafted from the pages of a mystery novel
was found nesting in a window. At the National
Museum of Scotland, a paper tail was spotted emerging
from the spine of Sir Arthur Conan Doyle’s book
The Lost World. Inside, a dinosaur charges through
shredded pages of the open book. More creations
appeared at more than a few additional places where
literature and artifacts are related to books and writing.

Therefore, a total of ten sculptures were bestowed on
special institutions, whose staff are thrilled by their luck.

The creator of these sculptures are not known
because no one has claimed responsibility. So far, that
is. The last gift came with a note in which the mystery
artist reveals her gender. Whatever: whoever created

the art, your intention is clear. Each gift came with a

note expressing special gratitude for “libraries, books,

words, ideas.” 13

4. F. NO CHANGE
G. Cinema, a three-dimensional sculpted, scene
H. Cinema a three-dimensional sculpted scene,
J. Cinema a three-dimensional, sculpted, scene

5. A. NO CHANGE
B. movie theaters as horse’s leaps
C. a movie theater as horses leap
D. movie theater’s as horse leap

6. F. NO CHANGE
G. dragon—crafted from the pages
H. dragon, crafted from the pages,
J. dragon crafted from the pages,

7. A. NO CHANGE
B. a number of additional cultural institutions support-
ing intellectual endeavors dedicated to promoting
C. quite a lot of other cultural institutions character-
ized by loyalty and dedication to
D. several libraries and museums devoted to

8. F. NO CHANGE
G. Eventually,
H. Of course,
J. However,

9. A. NO CHANGE
B. creators of this sculptures are
C. creator of these sculptures is
D. creators of this sculptures is

10. F. NO CHANGE
G. Disregarding the unknown identity of the person
who
H. Without consideration of or concern about whoever
J. Regardless of who

11. A. NO CHANGE
B. whose
C. her
D. our

12. F. NO CHANGE
G. note of gratitude expressing special gratefulness
and thanks
H. thank-you note on each one expressing special
thanks
J. thankful note expressing special thanks

13. If the writer were to delete the preceding sentence, the
paragraph would primarily lose a statement that:
A. suggests the essay writer knows the identity of the
artist.
B. explains why the artist created the sculptures.
C. proves the artist is a woman.
D. indicates the artist is a librarian.

GO ON TO THE NEXT PAGE.



Ironically, the creator of these exquisite sculptures who destroyed books—cutting them¹⁴ up with refashioning them into elaborate works¹⁵ of art—as “a tiny gesture in support of the special places.” The mystery artist celebrated the magic of those places and, at the same time, made some magic.

14. F. NO CHANGE
 G. for whom books were destroyed—
 H. as she destroyed books—
 J. destroyed books—
15. A. NO CHANGE
 B. and
 C. nor
 D. so

PASSAGE II
Building a Cork Boat

[1]

As a young boy, John Pollack dreamed of building a full-size boat made entirely of bottle corks. [A] At the age of thirty-four, Pollack sailed his dream down the Douro River in Portugal. It all began as Pollack is likely to point out, with¹⁶ a single cork.

[2]

To amass the staggering number of corks needed to construct the boat, 165,231 in all, Pollack convinced the¹⁷ staff, of several restaurants¹⁷ in Washington, DC, to donate discarded corks for his cause. [B] Pollack eventually received cork donations from a cork-importing company¹⁸ based in Portugal.

[3]

Constructing the boat introduced a challenge of another variety. Pollack finally¹⁹ tried gluing the corks together to create stackable logs, but he soon realized that this strategy was too time-consuming. [C]

16. F. NO CHANGE
 G. began, as Pollack is likely to point out,
 H. began, as Pollack is likely to point out
 J. began as Pollack is likely to point out
17. A. NO CHANGE
 B. boat (165,231) in all, Pollack convinced the staff of several restaurants,
 C. boat—165,231 in all—Pollack convinced the staff of several restaurants
 D. boat, 165,231, in all, Pollack convinced the staff of several restaurants
18. F. NO CHANGE
 G. donations, from a cork-importing company,
 H. donations, from a cork-importing company
 J. donations from a cork-importing company,
19. A. NO CHANGE
 B. next
 C. first
 D. also

He calculated that it would have taken him and one other person more than a year's worth of eight-hour days to glue all the corks needed for the boat.

[4]

Piles of corks threatened to take over Pollack's apartment. He used a foam template to assemble a

group of corks into a pretty interesting shape. He then fastened each cluster of corks with multiple rubber bands and encased each cluster in fishnet.

To bind clusters together and shaping them into flexible columns proved to be both efficient and architecturally

sound. Dozens of friends expedited this proper process by volunteering to help with the construction of the boat.

[5]

The completed cork boat, which resembled a Viking ship, was more impressive than Pollack had ever imagined.

[D] In his childhood imagination, he had saw himself floating the boat in his neighbor's swimming pool. But

at a length of twenty-two feet, Pollack's masterpiece

was best suited with a grand voyage. In 2002, the

company that had donated thousands of corks to Pollack's project sponsored the vessel's launch in Portugal. There, during the boat's successful journey on the Douro River, in the country of Portugal, Pollack's dream was fully realized.

20. F. NO CHANGE
G. than a year's
H. than a years'
J. then a years

21. Which choice most effectively introduces the paragraph?
A. NO CHANGE
B. Over the course of many months, Pollack convinced people to help.
C. Pollack was afraid that he would have to put his cork boat dream on hold.
D. After a series of trials, Pollack devised a workable strategy.

22. Which choice provides the most specific description of the assembled groups of corks?
F. NO CHANGE
G. hexagonal
H. certain
J. DELETE the underlined portion.

23. A. NO CHANGE
B. Binding clusters together and to shape
C. Binding clusters together and shaping
D. Binding clusters together and shape

24. Which choice best indicates that constructing the cork boat was challenging?
F. NO CHANGE
G. authentic
H. rigorous
J. grim

25. A. NO CHANGE
B. had seen himself
C. seen himself
D. saw him

26. F. NO CHANGE
G. length, of twenty-two feet,
H. length of twenty-two feet;
J. length of twenty-two feet

27. A. NO CHANGE
B. most well suited to
C. better suited for
D. best suited as

28. F. NO CHANGE
G. company, which
H. company whom
J. company, who

29. A. NO CHANGE
B. River, which is a river in Portugal,
C. River in Portugal,
D. River,



Question 30 asks about the preceding passage as a whole.

30. The writer wants to add the following sentence to the essay:

“Remember,” he would say as he made his daily pickups, “every cork counts.”

The sentence would most logically be placed at:

- F. Point A in Paragraph 1.
- G. Point B in Paragraph 2.
- H. Point C in Paragraph 3.
- J. Point D in Paragraph 5.

PASSAGE III

Lightning in the Sand

As my friend Anna and I walked the sand dunes of southeastern New Mexico, she told me that she hoped we’d find a fulgurite, one as translucent white as the southeastern New Mexico sands around us. A fulgurite³¹—whose name stems from the Latin word *fulgur*, which means “thunderbolt”—is a hollow silica glass tube formed when lightning strikes sand. A fulgurite is created in one explosive second by fusion and pressure as sand heated by a lightning blast melts,³² and becomes glass. Commonly called “petrified lightning,” a fulgurite places³³ the shape of a miniature lightning bolt into the earth, often branching deep into the ground.

Anna told me that I had possibly seen a small fragment of a fulgurite before, without realizing I had, on a beach. She explained though that even experts³⁴ are rarely able to locate a fully intact fulgurite.

31. A. NO CHANGE
 B. and nearly transparent to the eye almost as the white sands of these dunes.
 C. as these sands.
 D. DELETE the underlined portion and end the sentence with a period.
32. F. NO CHANGE
 G. sand heated (by a lightning blast) melts
 H. sand, heated by a lightning blast melts,
 J. sand heated by a lightning blast melts
33. Which choice best builds on the preceding sentence by emphasizing the dramatic nature of the mark a fulgurite leaves on the earth?
 A. NO CHANGE
 B. sketches
 C. burns
 D. sends
34. F. NO CHANGE
 G. explained, though, that even experts
 H. explained though that, even experts,
 J. explained, though that even experts



The thin, brittle glass tubes break easily. Occasionally,
³⁵
 after strong, sustained winds have shifted desert sands,

while an unbroken, previously buried fulgurite will be
³⁶
 revealed, showing as a tube protruding from the ground.

37 I scanned the area, hopeful that I'd see a tube newly

uncovered. Anna made clear that we'd be lucky to come
³⁸
 upon a small piece of fulgurite, just a few inches long.

Anna had shown me fulgurites she had found
 on other trips. Their colors ranged from black to
 brown to green, corresponding to the color of the
 sand in which she had discovered them. I wasn't
 surprised that I'd never recognized fulgurites on
 any beach: no one had ever told me what to look for.
³⁹

35. Given that all the statements are true, which one provides the most relevant information at this point in the essay?
- A. NO CHANGE
 - B. Human-made fulgurites are not any easier to excavate than naturally occurring fulgurites.
 - C. A fulgurite is not a geode (a crystal-lined stone), though the two are often confused.
 - D. Still, pieces of fulgurite can be worked into jewelry.
36. F. NO CHANGE
 G. however
 H. so
 J. DELETE the underlined portion.
37. Which of the following sentences, if added here, best connects the preceding sentence to the information that follows in the paragraph?
- A. Anna told me that there had been a brief rain shower in the area the day before.
 - B. I could see bright pink sand verbenas blooming in the distance.
 - C. Swift winds were moving the white sands that day.
 - D. Dig carefully.
38. F. NO CHANGE
 G. uncovered, I focused my gaze on the sands in the distance.
 H. uncovered, I looked closely.
 J. had it been uncovered.
39. Which choice most effectively concludes this sentence and leads into the information that follows in the paragraph?
- A. NO CHANGE
 - B. I focus on looking for seashells, sand dollars, and smooth rocks when I'm walking the sands.
 - C. usually, I'm not in the mood for a science project when I'm on vacation.
 - D. on their surface, they look like pieces of tree branches.

1



1

Their interiors, though, are smooth, clear glass stained
40

with tiny bubbles trapped formed by air and moisture
41
during the rapid cooling of the melted sand after the lightning strike.

We continued exploring the dunes.

Anna laughed and said we needed only to stop at the local gift shop to unearth
42

our treasure. 43 But given

our luck finding fulgurites in
44

deserts and on beaches, she wanted to
45
keep searching to find our own piece of bright, white lightning in the sand.

40. Which choice makes clearest the light, sporadic arrangement of the bubbles in the glass?

- F. NO CHANGE
- G. pointed
- H. speckled
- J. covered

41. The best placement for the underlined portion would be:

- A. where it is now.
- B. after the word *bubbles*.
- C. after the word *during*.
- D. after the word *cooling*.

42. F. NO CHANGE
G. for having unearthed
H. that would unearth
J. unearthing

43. If the writer deleted the preceding sentence, the essay would primarily lose a:

- A. bluntly critical comment that makes clear Anna's frustration with trying to find a white fulgurite in the sand dunes of New Mexico.
- B. mildly scolding response by Anna to the narrator's impatience with the time and attention it might take for them to find a white fulgurite.
- C. light moment in the form of a good-natured joke by Anna about how easy it could be to find a white fulgurite.
- D. moment of excitement when Anna remembers that they could easily find a white fulgurite at the local gift shop.

44. F. NO CHANGE
G. her
H. my
J. their

45. Which of the following alternatives to the underlined portion would provide the essay with new information?

- A. beaches in Florida, Utah, California, and Nevada,
- B. beaches, but so far not this day in the New Mexico sands,
- C. beaches, in other words, sandy locales,
- D. beaches, even a green fulgurite,



PASSAGE IV

Planet Earth's Windiest Observatory

[1]

Step outside into blowing snow, freezing fog, 45 mph winds with hurricane-force gusts, and a -50° Fahrenheit windchill. Welcome to a typical January day at the Mount Washington Observatory. [A] Weather conditions at this facility, which sits atop its namesake's 6,288-foot peak⁴⁶

in New Hampshire, has earned the location the nickname⁴⁷ "Home of the World's Worst Weather."⁴⁸

[2]

[B] Though somewhat diminutive compared to other mountains, (Colorado's Pikes Peak, for⁴⁸ example, is more than twice its height), Mount Washington is the tallest peak in the Presidential Range. The peak⁴⁹ stands at the confluence of three major storm tracks,

and its steep slopes force rising winds to accelerate.⁵⁰

In fact, scientists in 1934 recorded a surface wind

speed (of 231 mph): one of the fastest ever recorded.⁵¹

46. F. NO CHANGE

G. their

H. these

J. it's

47. A. NO CHANGE

B. Hampshire, have earned

C. Hampshire has earned

D. Hampshire, earns

48. F. NO CHANGE

G. mountains (Colorado's Pikes Peak,

H. mountains, (Colorado's Pikes Peak

J. mountains (Colorado's Pikes Peak

49. Given that all the choices are accurate, which one best uses a comparison to emphasize that the weather on Mount Washington can be extreme?

A. NO CHANGE

B. is much colder at the summit than at the base of the mountain.

C. has an average midwinter temperature of 5° Fahrenheit.

D. has weather that rivals that of Antarctica.

50. F. NO CHANGE

G. its steep slopes that force

H. if its steep slopes force

J. its steep slopes forcing

51. A. NO CHANGE

B. speed of 231 mph—

C. speed of 231 mph;

D. speed, of 231 mph,



[3]

In one study, researchers used a laser beam and advanced optical techniques to measure winds. The observatory also keeps detailed weather records that scientists have used to track climate trends and weather patterns. The observatory has also advanced scientists'

52

understanding of clouds, of ice physics, and the atmosphere.

53

[4]

To conduct all this research, staff are on-site year-round. Observers, who work several twelve-hour shifts over the course of a week. To change personnel in winter, though, crews ascend the mountain in a

55

vehicle, gripping the snow using revolving tracks similar to those on a military tank. Observers go outside every hour to gather data, which they send to the National Weather Service. [C]

56

[5]

Though isolated, the Mount Washington Observatory offers weather enthusiasts many ways to get involved. The observatory takes volunteers and accepts interns, who assist with research. The bold can take part in educational trips to the summit in winter. [D] For those who are planning to make a trip to Mount Washington, the observatory has a website with live video feeds of the summit.

57

58

52. F. NO CHANGE
G. In addition, the
H. Additionally, the
J. Also, the
53. A. NO CHANGE
B. furthered our knowledge of ice physics,
C. as well as ice physics,
D. ice physics,

54. F. NO CHANGE
G. Observers who work
H. Observers work
J. Observers, working

55. A. NO CHANGE
B. winter, of course,
C. winter, however,
D. winter,

56. F. NO CHANGE
G. vehicle while gripping
H. vehicle that grips
J. vehicle and grip

57. A. NO CHANGE
B. research and the
C. research but the
D. research, the

58. Which choice contrasts most directly with the other ways to get involved at the observatory that are mentioned in the paragraph?
F. NO CHANGE
G. prefer a warm recliner to an icy peak,
H. conduct weather research,
J. love the outdoors,



Questions 59 and 60 ask about the preceding passage as a whole.

59. The writer is considering adding the following sentence to the essay:

This information is used to help create regional weather forecasts.

If the writer were to add this sentence, it would most logically be placed at:

- A. Point A in Paragraph 1.
- B. Point B in Paragraph 2.
- C. Point C in Paragraph 4.
- D. Point D in Paragraph 5.

60. Suppose the writer’s main purpose had been to describe how mountain ranges affect weather patterns. Would this essay accomplish that purpose?

- F. Yes, because it discusses how the slopes of Mount Washington increase wind speeds.
- G. Yes, because it describes the weather conditions on the summit of Mount Washington.
- H. No, because it outlines the history of the Mount Washington Observatory.
- J. No, because it provides an overview of the Mount Washington Observatory and its research.

PASSAGE V

The Real McCoy

[1]

“It’s the real McCoy.” You might have heard this expression before, but who—or what—is a McCoy, real or otherwise? The saying has been used for generations to declare its’ the genuine article, the original and best.

[A] While its origin is disputed, many people believe the expression was inspired by the inventions of a Canadian American engineer named, Elijah McCoy. McCoy, a railroad worker who, as a teenager, had formally studied mechanical engineering, revolutionized railroad and factory operations, affecting both incredibly with his dozens of patented products.

61. A. NO CHANGE
B. its something that’s
C. that something is
D. that its

62. F. NO CHANGE
G. American engineer named
H. American, engineer named,
J. American, engineer named

63. A. NO CHANGE
B. operations, changing both of these industries fundamentally
C. operations, so that they would never be the same
D. operations



[2]

While working for the Michigan Central Railroad in the 1870s, then McCoy was assigned to work on the wheel

64

bearings and axles of trains. [65] Trains needed to come to a halt after only a few miles of travel so that the moving parts could be oiled by hand—a tedious, time-consuming process. McCoy invented a device that released oil while

a train was in motion, substantially reducing the number

66

of maintenance stops had the effect of making travel more efficient. [B] This automatic lubricating device became the first of his fifty-seven patents.

[3]

McCoy applied the principles of this invention to other engineering challenges. Factories in the late 1800s, for example, increasingly relied on steam engines to

68

power factory machines. As with trains, therefore many of the machines' parts had to be oiled manually.

69

McCoy, recognizing the similarities between train wheels and factory machines, designed automated oilers for steam engines. These innovations allowed

70

64. F. NO CHANGE
G. with that company
H. during this time
J. DELETE the underlined portion.
65. In the preceding sentence, the writer is considering revising the phrase “assigned to work on” to “responsible for oiling.” Given that the revised phrase is accurate, should the writer make this revision?
A. Yes, because the revision specifically describes the procedures McCoy had to follow as he maintained the wheel bearings and axles of trains.
B. Yes, because the revision provides a clearer connection between McCoy’s main task as a railroad worker and his first patented device.
C. No, because the revision doesn’t indicate whether McCoy chose to oil the wheel bearings and axles of trains by hand.
D. No, because the revision doesn’t make clear whether McCoy had worked on trains for other railroad companies.
66. F. NO CHANGE
G. lessening the frequency of number
H. subtracting the amount
J. lowering the amount
67. A. NO CHANGE
B. and making
C. helping to make
D. made
68. F. NO CHANGE
G. subsequently,
H. regardless,
J. however,
69. A. NO CHANGE
B. the problem being
C. in that
D. DELETE the underlined portion.
70. F. NO CHANGE
G. McCoy would recognize
H. McCoy, a recognition of
J. McCoy recognized

factories to give machines a certain timelessness,

71

increasing factory productivity and, as a result, profits. 72

[4]

McCoy's inventions were an instant success. [C] Not surprisingly, other inventors inundated the market with similar—and usually inferior—devices. [D] Supposedly, factory owners who wanted a product proven to do it⁷³ would ask if their purchase was “the real McCoy.” McCoy's inventions would continue to benefit industries in the United States well into the twentieth century, as his⁷⁴ name became synonymous with quality and authenticity.

74

71. Which choice offers the clearest and most precise information about how the operation of factory machines changed as a result of McCoy's innovations?

- A. NO CHANGE
- B. rethink operations,
- C. run machines continuously,
- D. use machines differently,

72. The writer is considering deleting the following phrase from the preceding sentence (ending the sentence with a period):

and, as a result, profits.

Should the writer make this deletion?

- F. Yes, because the phrase shifts the focus of the paragraph from the use of McCoy's inventions in factories to factory disputes.
- G. Yes, because the phrase suggests that factory owners were more interested in profits than in which of McCoy's devices would best meet their needs.
- H. No, because the phrase is relevant to the paragraph's discussion of the positive effects that the use of McCoy's inventions had in factories.
- J. No, because the phrase makes clear that the successful use of McCoy's inventions in factories led to higher wages for factory workers.

73. A. NO CHANGE

- B. lend itself to superiority
- C. give off the best result
- D. work well

74. Which choice best concludes the essay by reiterating its main idea?

- F. NO CHANGE
- G. so, not surprisingly, in 2001 McCoy was inducted into the National Inventors Hall of Fame, located in Alexandria, Virginia.
- H. even having applications in the booming aluminum manufacturing industry of the 1940s.
- J. making this story, for so many reasons, “the genuine article.”

Question 75 asks about the preceding passage as a whole.

75. The writer is considering adding the following true statement to the essay:

The imitators expected that the price of their products—often significantly lower than the price of McCoy's devices—would attract buyers, but price didn't seem to matter most.

If the writer were to add this statement, it would most logically be placed at:

- A. Point A in Paragraph 1.
- B. Point B in Paragraph 2.
- C. Point C in Paragraph 4.
- D. Point D in Paragraph 4.

END OF TEST 1

STOP! DO NOT TURN THE PAGE UNTIL TOLD TO DO SO.



MATHEMATICS TEST

60 Minutes—60 Questions

DIRECTIONS: Solve each problem, choose the correct answer, and then fill in the corresponding oval on your answer document.

Do not linger over problems that take too much time. Solve as many as you can; then return to the others in the time you have left for this test.

You are permitted to use a calculator on this test. You may use your calculator for any problems you choose,

but some of the problems may best be done without using a calculator.

Note: Unless otherwise stated, all of the following should be assumed.

1. Illustrative figures are NOT necessarily drawn to scale.
2. Geometric figures lie in a plane.
3. The word *line* indicates a straight line.
4. The word *average* indicates arithmetic mean.

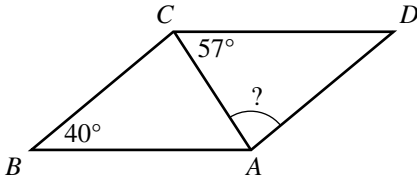
1. Marcus's favorite casserole recipe requires 3 eggs and makes 6 servings. Marcus will modify the recipe by using 5 eggs and increasing all other ingredients in the recipe proportionally. What is the total number of servings the modified recipe will make?
 - A. 6
 - B. 8
 - C. 10
 - D. 12
 - E. 15
2. The 35-member History Club is meeting to choose a student government representative. The members decide that the representative, who will be chosen at random, CANNOT be any of the 3 officers of the club. What is the probability that Hiroko, who is a member of the club but NOT an officer, will be chosen?
 - F. 0
 - G. $\frac{4}{35}$
 - H. $\frac{1}{35}$
 - J. $\frac{1}{3}$
 - K. $\frac{1}{32}$
3. For what value of x is the equation $2^{2x+7} = 2^{15}$ true?
 - A. 2
 - B. 4
 - C. 11
 - D. 16
 - E. 44
4. Let the function f be defined as $f(x) = 5x^2 - 7(4x + 3)$. What is the value of $f(3)$?
 - F. -18
 - G. -26
 - H. -33
 - J. -60
 - K. -75
5. A wallet containing 5 five-dollar bills, 7 ten-dollar bills, and 8 twenty-dollar bills is found and returned to its owner. The wallet's owner will reward the finder with 1 bill drawn randomly from the wallet. What is the probability that the bill drawn will be a twenty-dollar bill?
 - A. $\frac{1}{20}$
 - B. $\frac{4}{51}$
 - C. $\frac{1}{8}$
 - D. $\frac{2}{5}$
 - E. $\frac{2}{3}$
6. The ABC Book Club charges a \$40 monthly fee, plus \$2 per book read in that month. The Easy Book Club charges a \$35 monthly fee, plus \$3 per book read in that month. For each club, how many books must be read in 1 month for the total charges from each club to be equal?
 - F. 1
 - G. 4
 - H. 5
 - J. 6
 - K. 75
7. In parallelogram $ABCD$ below, \overline{AC} is a diagonal, the measure of $\angle ABC$ is 40° , and the measure of $\angle ACD$ is 57° . What is the measure of $\angle CAD$?
 
 - A. 40°
 - B. 57°
 - C. 77°
 - D. 83°
 - E. 97°

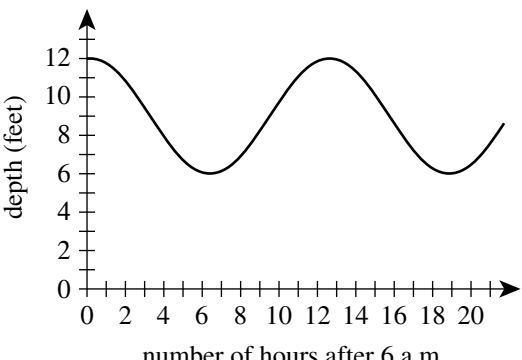

8. When $x = \frac{1}{2}$, what is the value of $\frac{8x-3}{x}$?
- F. $\frac{1}{2}$
 G. 2
 H. $\frac{5}{2}$
 J. 5
 K. 10
9. In the standard (x,y) coordinate plane, what is the midpoint of the line segment that has endpoints $(3,8)$ and $(1,-4)$?
- A. $(-2,-12)$
 B. $(-1, -6)$
 C. $(\frac{11}{2}, -\frac{3}{2})$
 D. $(2, 2)$
 E. $(4,-12)$
10. The fluctuation of water depth at a pier is shown in the figure below. One of the following values gives the positive difference, in feet, between the greatest water depth and the least water depth shown in this graph. Which value is it?
- 
- F. 3
 G. 6
 H. 9
 J. 12
 K. 19
11. What is the slope of the line through $(-2,1)$ and $(2,-5)$ in the standard (x,y) coordinate plane?
- A. $\frac{3}{2}$
 B. 1
 C. -1
 D. $-\frac{3}{2}$
 E. -4
12. In Cherokee County, the fine for speeding is \$17 for each mile per hour the driver is traveling over the posted speed limit. In Cherokee County, Kirk was fined \$221 for speeding on a road with a posted speed limit of 30 mph. Kirk was fined for traveling at what speed, in miles per hour?
- F. 13
 G. 17
 H. 43
 J. 47
 K. 60
13. What is the sum of the solutions of the 2 equations below?
- $$\begin{aligned} 8x &= 12 \\ 2y + 10 &= 22 \end{aligned}$$
- A. $2\frac{2}{5}$
 B. $7\frac{1}{2}$
 C. 9
 D. 10
 E. $17\frac{1}{2}$
14. The average of 5 distinct scores has the same value as the median of the 5 scores. The sum of the 5 scores is 420. What is the sum of the 4 scores that are NOT the median?
- F. 315
 G. 320
 H. 336
 J. 350
 K. 360
15. What is the value of the expression below?
- $$| |-8 + 4| - |3 - 9| |$$
- A. -18
 B. -2
 C. 0
 D. 2
 E. 18
16. Which of the following expressions is equivalent to $x^{\frac{2}{3}}$?
- F. $\frac{x^2}{3}$
 G. $\frac{x(2)}{3}$
 H. $\sqrt{x^3}$
 J. $\sqrt[3]{x}$
 K. $\sqrt[3]{x^2}$

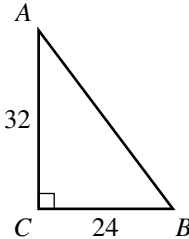

17. In the standard (x,y) coordinate plane, what is the slope of the line given by the equation $4x = 7y + 5$?
- A. $-\frac{4}{7}$
 B. $\frac{4}{7}$
 C. $\frac{7}{4}$
 D. 4
 E. 7
18. For which of the following conditions will the sum of integers m and n *always* be an odd integer?
- F. m is an odd integer.
 G. n is an odd integer.
 H. m and n are both odd integers.
 J. m and n are both even integers.
 K. m is an odd integer and n is an even integer.
19. The lengths of the 2 legs of right triangle $\triangle ABC$ shown below are given in inches. The midpoint of \overline{AB} is how many inches from A ?
- 
- A. 16
 B. 20
 C. 21
 D. 28
 E. 40
20. In $\triangle DEF$, the length of \overline{DE} is $\sqrt{30}$ inches, and the length of \overline{EF} is 3 inches. If it can be determined, what is the length, in inches, of \overline{DF} ?
- F. 3
 G. $\sqrt{30}$
 H. $\sqrt{33}$
 J. $\sqrt{39}$
 K. Cannot be determined from the given information
21. Laura plans to paint the 8-foot-high rectangular walls of her room, and before she buys paint she needs to know the area of the wall surface to be painted. Two walls are 10 feet wide, and the other 2 walls are 15 feet wide. The combined area of the 1 window and the 1 door in her room is 60 square feet. What is the area, in square feet, of the wall surface Laura plans to paint?
- A. 200
 B. 340
 C. 360
 D. 390
 E. 400
22. The length of a rectangle is 5 inches longer than the width. The perimeter of the rectangle is 40 inches. What is the width of the rectangle, in inches?
- F. 7.5
 G. 8
 H. 15
 J. 16
 K. 17.5
23. 8% of 60 is $\frac{1}{5}$ of what number?
- A. 0.96
 B. 12
 C. 24
 D. 240
 E. 3,750
24. Armin is trying to decide whether to buy a season pass to his college basketball team's 20 home games this season. The cost of an individual ticket is \$14, and the cost of a season pass is \$175. The season pass will admit Armin to any home basketball game at no additional cost. What is the minimum number of home basketball games Armin must attend this season in order for the cost of a season pass to be less than the total cost of buying an individual ticket for each game he attends?
- F. 8
 G. 9
 H. 12
 J. 13
 K. 20
25. $\frac{4.8 \times 10^{-7}}{1.6 \times 10^{-11}} = ?$
- A. 3.0×10^4
 B. 3.0×10^{-4}
 C. 3.0×10^{-18}
 D. 3.2×10^{18}
 E. 3.2×10^4
26. A circle in the standard (x,y) coordinate plane has center $C(-1,2)$ and passes through $A(2,6)$. Line segment \overline{AB} is a diameter of this circle. What are the coordinates of point B ?
- F. $(-6,-2)$
 G. $(-5,-1)$
 H. $(-4,-2)$
 J. $(4, 2)$
 K. $(5,10)$
27. Which of the following expressions is a factor of $x^3 - 64$?
- A. $x - 4$
 B. $x + 4$
 C. $x + 64$
 D. $x^2 + 16$
 E. $x^2 - 4x + 16$



28. The average of a list of 4 numbers is 90.0. A new list of 4 numbers has the same first 3 numbers as the original list, but the fourth number in the original list is 80, and the fourth number in the new list is 96. What is the average of this new list of numbers?

F. 90.0
G. 91.5
H. 94.0
J. 94.5
K. 94.8

29. The number a is located at -2.5 on the number line below.

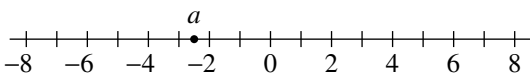

One of the following number lines shows the location of a^2 . Which number line is it?

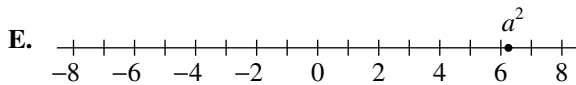
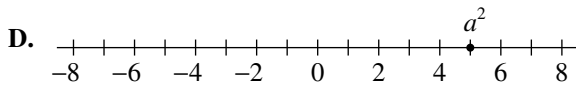
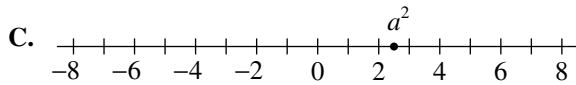
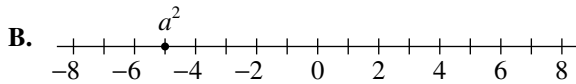
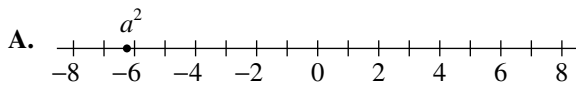

30. Maria ordered a pizza. She ate only $\frac{2}{9}$ of it and gave the remaining pizza to her 3 brothers. What fraction of the whole pizza will each of Maria's brothers receive, if they share the remaining pizza equally?

F. $\frac{7}{9}$
G. $\frac{3}{7}$
H. $\frac{1}{3}$
J. $\frac{7}{27}$
K. $\frac{2}{27}$

31. The number 1,001 is the product of the prime numbers 7, 11, and 13. Knowing this, what is the prime factorization of 30,030?

A. $3 \cdot 7 \cdot 10 \cdot 13$
B. $30 \cdot 7 \cdot 11 \cdot 13$
C. $2 \cdot 5 \cdot 7 \cdot 11 \cdot 13$
D. $3 \cdot 7 \cdot 10 \cdot 11 \cdot 13$
E. $2 \cdot 3 \cdot 5 \cdot 7 \cdot 11 \cdot 13$

Use the following information to answer questions 32–34.

Mikea, an intern with the Parks and Recreation Department, is developing a proposal for the new trapezoidal Springdale Park. The figure below shows her scale drawing of the proposed park with 3 side lengths and the radius of the merry-go-round given in inches. In Mikea's scale drawing, 1 inch represents 1.5 feet.

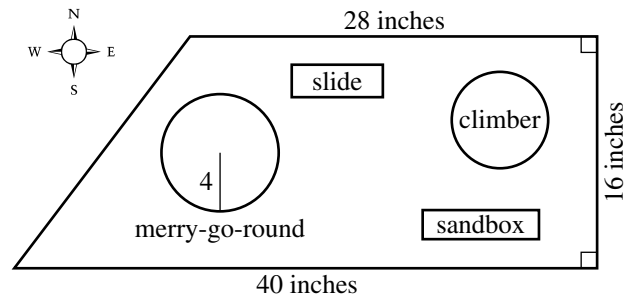

32. What is the area, in square inches, of the scale drawing of the park?

F. 448
G. 544
H. 640
J. 672
K. 1,088

33. Mikea's proposal includes installing a fence on the perimeter of the park. What is the perimeter, in feet, of the park?

A. 84
B. 88
C. 104
D. 126
E. 156

34. The length of the south side of the park is what percent of the length of the north side?

F. 112%
G. 124%
H. $142\frac{6}{7}\%$
J. 175%
K. 250%



Use the following information to answer questions 35–37.

The Smith family is planning to build a 3-room cabin which consists of 2 bedrooms (BR) and 1 living room (LR). Shown below are the rectangular floor plan (left figure) and a side view of the cabin (right figure). In the side view, the roof forms an isosceles triangle ($\triangle ABC$), the walls are perpendicular to the level floor (\overline{ED}), $\overline{AC} \parallel \overline{ED}$, F is the midpoint of \overline{AC} , and $\overline{BF} \perp \overline{AC}$.

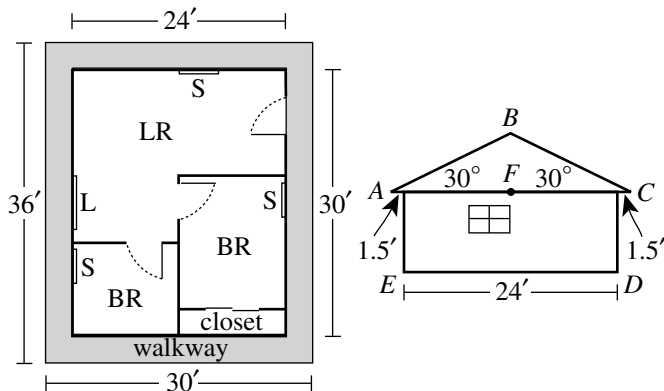

During the week the Smiths plan to roof the cabin, there is a 20% chance of rain each day.

35. Mr. Smith plans to build a 3-foot-wide walkway around the outside of the cabin, as shown in the floor plan. What will be the area, in square feet, of the top surface of the walkway?
- A. 171
B. 324
C. 360
D. 396
E. 720
36. Mrs. Smith will install a ceiling fan in each room of the cabin and will place curtains over the 4 windows. Each of the ceiling fans has a price of \$52.00. The price of curtains for each small window (S) is \$39.50, and the price of curtains for the large window (L) is twice that for the small window. Based on this information, which of the following values is closest to the total price Mrs. Smith will pay for curtains and ceiling fans?
- F. \$262
G. \$302
H. \$341
J. \$354
K. \$393

37. Mr. and Mrs. Smith plan to roof the cabin on 2 consecutive days. Assuming that the chance of rain is independent of the day, what is the probability that it will rain both days?

A. 0.04
B. 0.08
C. 0.16
D. 0.20
E. 0.40

38. Which of the following expressions, when evaluated, equals an irrational number?

F. $\frac{\sqrt{2}}{\sqrt{8}}$
G. $\frac{\sqrt{8}}{\sqrt{2}}$
H. $(\sqrt{8})^2$
J. $\sqrt{2} \times \sqrt{8}$
K. $\sqrt{2} + \sqrt{8}$

39. A line through the origin and (10,4) is shown in the standard (x,y) coordinate plane below. The acute angle between the line and the positive x -axis has measure θ . What is the value of $\tan \theta$?

A. $\frac{\sqrt{29}}{2}$
B. $\frac{2}{\sqrt{29}}$
C. $\frac{5}{\sqrt{29}}$
D. $\frac{2}{5}$
E. $\frac{5}{2}$

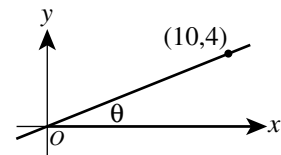

40. The equation $|2x - 8| + 3 = 5$ has 2 solutions. Those solutions are equal to the solutions to which of the following pairs of equations?

F. $2x - 5 = 5$
 $-2x - 5 = -5$
G. $2x - 8 = 2$
 $-2x - 8 = 2$
H. $2x - 8 = 8$
 $-(2x - 8) = 8$
J. $2x - 8 = 2$
 $-(2x - 8) = 8$
K. $2x - 8 = 2$
 $-(2x - 8) = 2$



41. The frequency chart below shows the cumulative number of Ms. Hernandez's science students whose test scores fell within certain score ranges. All test scores are whole numbers.

Score range	Cumulative number of students
65–70	12
65–80	13
65–90	19
65–100	21

How many students have a test score in the interval 71–80 ?

- A. 1
B. 6
C. 8
D. 12
E. 13
42. The number of decibels, d , produced by an audio source can be modeled by the equation $d = 10 \log\left(\frac{I}{K}\right)$, where I is the sound intensity of the audio source and K is a constant. How many decibels are produced by an audio source whose sound intensity is 1,000 times the value of K ?
- F. 4
G. 30
H. 40
J. 100
K. 10,000
43. Mario plays basketball on a town league team. The table below gives Mario's scoring statistics for last season. How many points did Mario score playing basketball last season?

Type of shot	Number attempted	Percent successful
1-point free throw	80	75%
2-point field goal	60	90%
3-point field goal	60	25%

- A. 129
B. 190
C. 213
D. 330
E. 380

44. The graph of $y = |x - 6|$ is in the standard (x, y) coordinate plane. Which of the following transformations, when applied to the graph of $y = |x|$, results in the graph of $y = |x - 6|$?

- F. Translation to the right 6 coordinate units
G. Translation to the left 6 coordinate units
H. Translation up 6 coordinate units
J. Translation down 6 coordinate units
K. Reflection across the line $x = 6$

45. Toby wants to find the volume of a solid toy soldier. He fills a rectangular container 8 cm long, 6 cm wide, and 10 cm high with water to a depth of 4 cm. Toby totally submerges the toy soldier in the water. The height of the water with the submerged toy soldier is 6.6 cm. Which of the following is closest to the volume, in cubic centimeters, of the toy soldier?

- A. 125
B. 156
C. 192
D. 208
E. 317

46. A box in the shape of a cube has an interior side length of 18 inches and is used to ship a right circular cylinder with a radius of 6 inches and a height of 12 inches. The interior of the box not occupied by the cylinder is filled with packing material. Which of the following numerical expressions gives the number of cubic inches of the box filled with packing material?

- F. $6(18)^2 - 2\pi(6)(12) - 2\pi(6)^2$
G. $6(18)^2 - 2\pi(6)(12)$
H. $18^3 - \pi(6)(12)^2$
J. $18^3 - \pi(6)^2(12)$
K. $18^3 - \pi(12)^3$

47. A room has a rectangular floor that is 15 feet by 21 feet. What is the area of the floor in square yards ?

- A. 24
B. 35
C. 36
D. 105
E. 144



48. ABC Cabs and Tary Taxicabs both have an initial fare of a whole number of dollars for 1 passenger. The fare increases a whole number of dollars at each whole number of miles traveled. The graphs below show the 1-passenger fares, in dollars, for both cab companies for trips up to 6 miles. When the fares of the 2 cab companies are compared, what is the cheaper fare for a 5-mile trip?

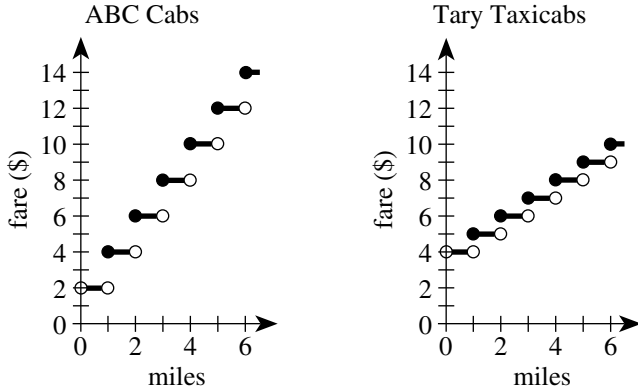

- F. \$ 8
- G. \$ 9
- H. \$10
- J. \$11
- K. \$12

49. The graph of a function $y = f(x)$ consists of 3 line segments. The graph and the coordinates of the endpoints of the 3 line segments are shown in the standard (x,y) coordinate plane below. What is the area, in square coordinate units, of the region bounded by the graph of $y = f(x)$, the positive y -axis, and the positive x -axis?

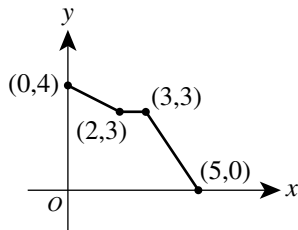

- A. 10
- B. 13
- C. 14
- D. 15
- E. 20

50. The sum of 2 positive numbers is 151. The lesser number is 19 more than the square root of the greater number. What is the value of the greater number minus the lesser number?

- F. 19
- G. 66
- H. 85
- J. 91
- K. 121

51. The list of numbers 41, 35, 30, X , Y , 15 has a median of 25. The mode of the list of numbers is 15. To the nearest whole number, what is the mean of the list?

- A. 20
- B. 25
- C. 26
- D. 27
- E. 30

52. You are given the following system of equations:

$$y = x^2$$

$$rx + sy = t$$

where r , s , and t are integers. For which of the following will there be more than one (x,y) solution, with real-number coordinates, for the system?

- F. $r^2 + 4st > 0$
- G. $s^2 - 4rt > 0$
- H. $r^2 - 4st < 0$
- J. $s^2 - 4rt < 0$
- K. $s^2 + 4rt < 0$

53. The 3rd and 4th terms of an arithmetic sequence are 13 and 18, respectively. What is the 50th term of the sequence?

- A. 248
- B. 250
- C. 253
- D. 258
- E. 263

54. One of the following graphs in the standard (x,y) coordinate plane is the graph of $y = \sin^2 x + \cos^2 x$ over the domain $-\frac{\pi}{2} \leq x \leq \frac{\pi}{2}$. Which one?

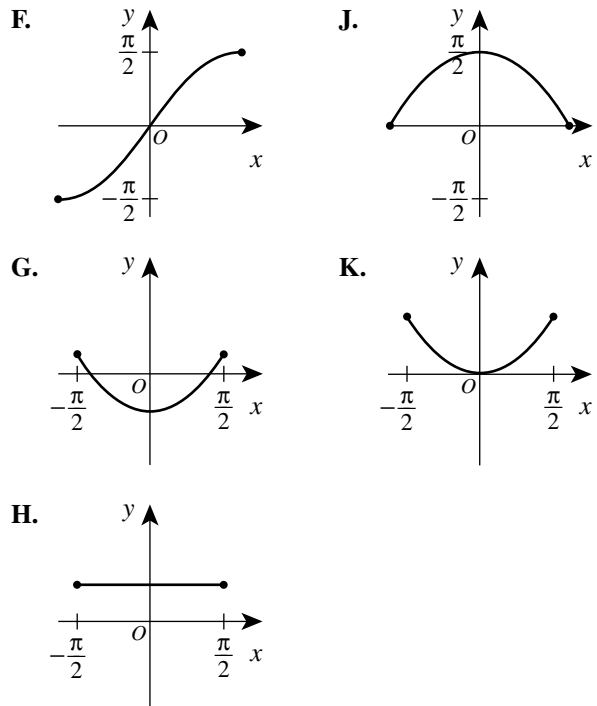



55. What is the period of the function $f(x) = \csc(4x)$?
- A. π
 B. 2π
 C. 4π
 D. $\frac{\pi}{4}$
 E. $\frac{\pi}{2}$
56. At the school carnival, Mike will play a game in which he will toss a penny, a nickel, and a dime at the same time. He will be awarded 3 points for each coin that lands with heads faceup. Let the random variable x represent the total number of points awarded on any toss of the coins. What is the expected value of x ?
- F. 1
 G. $\frac{3}{2}$
 H. $\frac{9}{2}$
 J. 6
 K. 9
57. For what positive real value of k , if any, is the determinant of the matrix $\begin{bmatrix} k & 4 \\ 3 & k \end{bmatrix}$ equal to k ?
 (Note: The determinant of matrix $\begin{bmatrix} a & b \\ c & d \end{bmatrix}$ equals $ad - bc$.)
- A. 3
 B. 4
 C. 12
 D. $\sqrt{12}$
 E. There is no such value of k .
58. Given a positive integer n such that $i^n = 1$, which of the following statements about n must be true?
 (Note: $i^2 = -1$)
- F. When n is divided by 4, the remainder is 0.
 G. When n is divided by 4, the remainder is 1.
 H. When n is divided by 4, the remainder is 2.
 J. When n is divided by 4, the remainder is 3.
 K. Cannot be determined from the given information
59. For $-\frac{\pi}{2} \leq \theta \leq \frac{\pi}{2}$, $|\sin \theta| \geq 1$ is true for all and only the values of θ in which of the following sets?
- A. $\left\{-\frac{\pi}{2}, \frac{\pi}{2}\right\}$
 B. $\left\{\frac{\pi}{2}\right\}$
 C. $\left\{\theta \mid -\frac{\pi}{2} < \theta < \frac{\pi}{2}\right\}$
 D. $\left\{\theta \mid -\frac{\pi}{2} \leq \theta \leq \frac{\pi}{2}\right\}$
 E. The empty set
60. Ray \overrightarrow{PK} bisects $\angle LPM$, the measure of $\angle LPM$ is $11x^\circ$, and the measure of $\angle LPK$ is $(4x + 18)^\circ$. What is the measure of $\angle KPM$?
- F. 12°
 G. $28\frac{2}{7}^\circ$
 H. 42°
 J. $61\frac{1}{5}^\circ$
 K. 66°

END OF TEST 2

STOP! DO NOT TURN THE PAGE UNTIL TOLD TO DO SO.

DO NOT RETURN TO THE PREVIOUS TEST.

READING TEST

35 Minutes—40 Questions

DIRECTIONS: There are several passages in this test. Each passage is accompanied by several questions. After reading a passage, choose the best answer to each question and fill in the corresponding oval on your answer document. You may refer to the passages as often as necessary.

Passage I

LITERARY NARRATIVE: This passage is adapted from the essay “Rough Water” by David McGlynn (©2008 by David McGlynn).

One of my best races could hardly be called a race at all. I was a senior in high school, gunning to qualify for the USA Junior Nationals. The previous summer I had missed the cut by less than a second in the mile, and just the day before, at my high school regional meet, I had come within three-tenths of a second in the 500-yard freestyle. The qualification time was 4:39.69; I swam a 4:39.95. The next day, Sunday, I drove with my mother to the far side of Houston where a time trial was being held—an informal, unadvertised event thrown together at the last minute. The only races swum were those the swimmers requested to swim. Most were short, flapping sprints in which swimmers attempted to shave off a few one-hundredths of a second. I didn’t have the courage to face the mile, and since I’d struck out in the 500 the day before, I decided to swim the 1,000-yard freestyle. Forty lengths of the pool. It was a race I’d swum fast enough to believe that given the right confluence of circumstances—cold water, an aggressive heat, an energetic meet—I could make the cut. I had fifteen seconds to drop to qualify.

By the time I stood up on the blocks, I was not only the only one in the race, I was practically the only one in the natatorium. The horn sounded and I dove in. I was angry and disheartened at having missed the cut the day before and I had little belief that I could go any faster today.

About six hundred yards in, my coach started to pace. I stayed steady on, not in a hurry, not about to get my hopes up. In my mind, I had already missed the time. Then a boy from a rival high school, whom I hardly knew, unfolded his legs and climbed down from the bleachers and started to cheer. He squatted low to the water and pointed his finger toward the end of the pool, as if to say, *That’s where you’re going, now hurry up.* I thought, *If he’s cheering, maybe I’m close.*

Sometimes a moment comes along when the world slows down, and though everything else moves around us at the same frenetic speed, we’re afforded the opportunity to reflect in real-time rather than in retrospect. It

is as though we slip into a worm-hole in the fabric of time and space, travel into the past and then back again to the present in the same instant. That morning, swimming, I remembered a day in late September the year before, the last day my swim team had use of an outdoor pool. All summer long my teammates and I swam under an open sky. After this day we would spend the rest of the season in a dank and moldy indoor pool.

The triangular backstroke flags were strung across the lanes and the adjacent diving well. My teammates liked to run down the long cement deck, jump out over the diving well, and try to grab hold of the line. Many of them could jump far enough to make it. I could not, though I tried every day. I tried that day, and missed. Since I would not have another shot until May, I decided to try again. I squared up and ran, my feet wet against the pavement, and just as my foot hit the water’s edge, one of my teammates called out “Jump!” I bent my knees and pushed off hard and got my hand around the flag line. I pulled the whole thing into the water. Autumn was coming and I wondered if there was a metaphor in what I had just done; a fortune folded inside a cookie: my greatest effort would come when I was down to my last opportunity.

Now it was March and I was down to my last opportunity, thinking about that day and hearing the word “Jump!” as my eyes followed the finger of the boy pointing me onward. What I understood—not later, but right then, in the water—was how little this swim added up to in the world. I had spent more than a year training for this one swim, and when it was finished the world would be no different than before it began. If no one else cared, then the swim was mine alone. It mattered because it was the task before me *now*, the thing I wanted *now*. Swimming, I had long understood, is a constant choice between the now and the later: exhaustion now for the sake of fitness later, all those Friday nights spent in the pool in pursuit of an end that seemed always one step farther on. I was out of laters, this was the end, and I made my choice. I cashed in the energy I set aside for climbing out of the pool and unfolding my towel and tying my shoes. I’ve never sprinted harder in my life, not before and not since. I hit the wall. I knew by instinct, by the spasm of my tendons and the ache in my bones, before I ever turned toward the clock or heard my coach scream, that I had made it.

1. The narrator of the passage can best be described as a swimmer who primarily:
 - A. recalls the swim of his life and the factors that motivated him during that swim.
 - B. remembers the events that inspired him to participate in a time trial at the Junior Nationals.
 - C. contrasts the joy of winning competitions early in the season with his later struggles to succeed.
 - D. chronicles his swimming career, from childhood through high school.
2. Which of the following events mentioned in the passage happened first chronologically?
 - F. The narrator stood on the blocks at the Sunday time trial his senior year.
 - G. The narrator leapt out over the diving well in late September.
 - H. The narrator swam the 500-yard freestyle in the high school regional meet as a senior.
 - J. The narrator heard a boy from a rival school cheering.
3. The narrator describes the natatorium as being nearly empty of spectators the day of his race in order to:
 - A. illustrate that the perfect racing conditions the narrator had hoped for weren't likely to occur.
 - B. demonstrate that, contrary to the narrator's expectations, the meet was energetic.
 - C. explain why the narrator's coach paced at the sound of the horn.
 - D. identify why the narrator felt a rush of energy before the race.
4. The narrator indicates that when he swam the 1,000-yard freestyle in the time trials, the world, for a moment, seemed to:
 - F. speed up, blurring past and present events.
 - G. rush past, forcing him to reflect in retrospect.
 - H. move in slow motion, as did everything around him.
 - J. slow down, allowing him to reflect in real time.
5. The passage indicates that during the narrator's swim at the time trial, he understood for the first time that:
 - A. his goals would always be one step farther on.
 - B. he had trained for this swim for over a year.
 - C. the swim was an event that was important to him alone.
 - D. swimming is a choice between the now and the later.
6. Based on the passage, the "end" the narrator mentions in line 80 most likely refers to his:
 - F. final pursuit of fitness.
 - G. last chance to qualify for Junior Nationals.
 - H. memory of his final Friday night practice.
 - J. ultimate realization that he had defeated the other competitors in the race.
7. The narrator of the passage characterizes the time trial in Houston as:
 - A. one long sprint in which swimmers attempted to improve their times.
 - B. a meet advertised as a way to qualify for the Junior Nationals.
 - C. a regional meet that featured only the 500-yard freestyle and 1,000-yard freestyle.
 - D. an informal swimming event put together at the last minute.
8. The statement "*That's where you're going, now hurry up*" (lines 35–36) can most directly be attributed to the:
 - F. cheering boy, as he verbally criticizes the narrator's efforts.
 - G. cheering boy, as he shouts encouragement to the narrator.
 - H. narrator, as he speculates about what the cheering boy meant when the boy pointed at the pool.
 - J. narrator, as he angrily contemplates his response to the cheering boy.
9. For the narrator, compared to practicing in the outdoor pool, practicing in the indoor pool is:
 - A. more productive.
 - B. more liberating.
 - C. less appealing.
 - D. less competitive.
10. When the narrator heard "Jump!" in his mind while swimming (line 67), he was most likely remembering:
 - F. his teammate's command the day the narrator caught the flag line.
 - G. his own shout as he leapt off the outdoor pool's deck that fall.
 - H. the cheers of the boy from the rival school.
 - J. the abrupt start of his race that Sunday.

Passage II

SOCIAL SCIENCE: Passage A is adapted from the book *Apple: A Global History* by Erika Janik (©2011 by Erika Janik). Passage B is adapted from the article “The Fatherland of Apples” by Gary Nabhan (©2008 by The Orion Society).

Passage A by Erika Janik

In early September of 1929, Nikolai Vavilov, famed Russian plant explorer and botanist, arrived in the central Asian crossroads of Alma-Ata, Kazakhstan. Climbing up the Zailiyskei Alatau slopes of the Tian Shan mountains separating Kazakhstan from China, Vavilov found thickets of wild apples stretching in every direction, an extensive forest of fruit coloured russet red, creamy yellow, and vibrant pink. Nowhere else in the world do apples grow thickly as a forest or with such incredible diversity. Amazed by what he saw, Vavilov wrote: ‘I could see with my own eyes that I had stumbled upon the centre of origin for the apple.’

With extraordinary prescience and few facts, Vavilov suggested that the wild apples he had seen growing in the Tian Shan were in fact the ancestors of the modern apple. He tracked the whole process of domestication to the mountains near Alma-Ata, where the wild apples looked awfully similar to the apples found at the local grocery. Unfortunately, Vavilov’s theory would remain mostly unknown for decades.

Exactly where the apple came from had long been a matter of contention and discussion among people who study plant origins. Vavilov, imprisoned by Joseph Stalin in 1940 for work in plant genetics that challenged Stalin’s beliefs, died in a Leningrad prison in 1943. Only after the fall of communism in Russia did Vavilov’s theory, made more than half a century earlier, become widely recognized.

As Vavilov predicted, it’s now believed that all of the apples known today are direct descendents of the wild apples that evolved in Kazakhstan. Apples do not comprise all of Kazakhstan’s plant bounty, however. At least 157 other plant species found in Kazakhstan are either direct precursors or close wild relatives of domesticated crops, including 90 per cent of all cultivated temperate fruits. The name of Kazakhstan’s largest city, Alma-Ata, or Almaty as it is known today, even translates as ‘Father of Apples’ or, according to some, ‘where the apples are’. So this news about the apple’s origins was probably no surprise to residents, particularly in towns where apple seedlings are known to grow up through the cracks in the pavements. The apple has been evolving in Central Asia for upwards of 4.5 million years.

Passage B by Gary Nabhan

Nikolai Vavilov is widely regarded as the world’s greatest plant explorer, for he made over 250,000 seed, fruit, and tuber collections on five continents. Kazakh conservationist Tatiana Salova credits him with first recognizing that Kazakhstan was the center of origin

and diversity for apples. “It is not surprising,” she concedes, “that when Vavilov first came to Kazakhstan to look at plants he was so amazed. Nowhere else in the world do apples grow as a forest. That is one reason why he stated that this is probably where the apple was born, this was its birthing grounds.”

Discerning where a crop originated and where the greatest portion of its genetic diversity remains extant may seem esoteric to the uninitiated. But knowing where exactly our food comes from—geographically, culturally, and genetically—is of paramount importance to the rather small portion of our own species that regularly concerns itself with the issue of food security. The variety of foods that we keep in our fields, orchards, and, secondarily, in our seed banks is critically important in protecting our food supply from plagues, crop diseases, catastrophic weather, and political upheavals. Vavilov himself was personally motivated to become an agricultural scientist by witnessing several famines during the czarist era of Russia. He hoped that by combining a more diverse seed portfolio with knowledge from both traditional farmers and collaborating scientists, the number of Russian families suffering from hunger might be reduced.

In a very real sense, the forests of wild foragers and the orchards of traditional farmers in such centers of crop diversity are the wellsprings of diversity that plant breeders, pathologists, and entomologists return to every time our society whittles the resilience in our fields and orchards down to its breaking point.

And whittle away we have done. Here in North America, according to apple historian Dan Bussey, some 16,000 apple varieties have been named and nurtured over the last four centuries. By 1904, however, the identities and sources of only 7,098 of those varieties could be discerned by USDA scientist W. H. Ragan. Since then, some 6,121 apple varieties—86.2 percent of Ragan’s 1904 inventory—have been lost from nursery catalogs, farmers’ markets, and from the American table.

11. The author’s use of the words and phrases “thickets,” “stretching in every direction,” and “extensive forest” (lines 6–7) in Passage A most nearly serves to emphasize which of the following points?
- The Tian Shan mountains are a challenge to navigate.
 - The apple varieties of Kazakhstan would be difficult for a botanist to catalog.
 - The diversity of plant species in Kazakhstan is crucially important.
 - The magnitude of wild apples in Kazakhstan is stunning.

12. The author of Passage A most likely states that the wild apples growing in the Tian Shan looked like apples found at the local grocery store to support the point that:
- F. many of the apples stocked in grocery stores are harvested in the Tian Shan.
 - G. in the Tian Shan, Vavilov had likely found the wild ancestors of the domesticated apple.
 - H. the wild apples growing in the Tian Shan are among the most popular varieties with consumers.
 - J. in the Tian Shan, Vavilov had found new apple varieties to introduce to food producers.
13. Passage A makes which of the following claims about plant species that are found in Kazakhstan?
- A. Approximately 157 species of cultivated temperate fruits originated in Kazakhstan.
 - B. Ninety percent of all domesticated crops are either direct precursors or close wild relatives of plant species found in Kazakhstan.
 - C. Of the plant species found in Kazakhstan, ninety percent are species of apples.
 - D. Aside from apples, at least 157 plant species found in Kazakhstan are either direct precursors or close wild relatives of domesticated crops.
14. Passage B most strongly suggests that Vavilov was motivated to become an agricultural scientist primarily because he:
- F. wanted to have one of his findings published.
 - G. aimed to work with a famous botanist.
 - H. wished to remedy a personal financial crisis.
 - J. hoped to help feed others.
15. The author of Passage B uses the phrase “whittle away” (line 80) to refer to the way that apple varieties have been:
- A. gradually lost from nursery catalogs, farmers’ markets, and the American table.
 - B. modified by plant breeders, entomologists, and pathologists to meet specialized needs.
 - C. weeded out by scientists until only the few thousand most resilient varieties remained.
 - D. pared down in 1904 to the few varieties that nursery catalogs wanted to feature.
16. As it is used in lines 82–83, the phrase *named and nurtured* most nearly means:
- F. nominated and encouraged.
 - G. identified and cultivated.
 - H. pointed to and groomed.
 - J. cited and fed.
17. In Passage B, it can most reasonably be inferred from the third paragraph (lines 74–79) that “centers of crop diversity” become crucially important when:
- A. plant breeders would like to learn more about the plant species of central Asia.
 - B. problems with a cultivated crop require experts to research a new variety of the crop.
 - C. consumers would like more variety in grocery produce departments.
 - D. disputes among plant breeders, pathologists, and entomologists lead to a reduction in crop variety.
18. Which of the following statements best describes the difference in the tone of the two passages?
- F. Passage A is defensive, whereas Passage B is dispassionate.
 - G. Passage A is solemn, whereas Passage B is optimistic.
 - H. Passage A is celebratory, whereas Passage B is cautionary.
 - J. Passage A is accusatory, whereas Passage B is sentimental.
19. Compared to the author of Passage A, the author of Passage B provides more information about the:
- A. reduction in the number of apple varieties in North America over the past four centuries.
 - B. methods Vavilov used to prove to other scientists that the apples growing in the Tian Shan are the ancestors of the modern apple.
 - C. number of apple varieties that are thriving in Kazakhstan today.
 - D. techniques used by researchers to determine the regions with the greatest genetic diversity in plants.
20. Passage A quotes Vavilov as saying “I could see with my own eyes that I had stumbled upon the centre of origin for the apple” (lines 11–12). In Passage B this quote is directly:
- F. invoked by the passage author as he imagines what Kazakhstan looked like centuries ago.
 - G. used to support an argument by USDA scientists.
 - H. paraphrased by Salova.
 - J. refuted by Bussey.

Passage III

HUMANITIES: This passage is adapted from the article “The Quiet Sideman” by Colin Fleming (©2008 by The American Scholar).

Near the end of his eight years as a recording-session musician, tenor saxophonist Leon “Chu” Berry landed a short-lived spot with Count Basie’s orchestra. Standing in for one of the Basie band’s two tenor giants, Berry took a lead solo on “Oh, Lady Be Good,” the 1924 Gershwin song that Basie had played for years. In the 28 seconds that the solo lasted on February 4, 1939, we are treated to no less than the musical personification of mind and body working together in divine tandem. When you hear the recording for the first time, you’re likely to wonder why you’ve never heard of Chu Berry before.

Why you’ve never heard of him is pretty simple: a lot of hard-core jazz buffs don’t know much about him. Berry was a solid session player who turns up on recordings with Basie, Bessie Smith, Fletcher Henderson, and Billie Holiday. But he did not cut many sessions himself as a leader, and when he soloed, he worked within the recording constraints of the era and the swing genre—fast-moving 78s with solos often lasting for a mere 32 beats.

The people who loved Berry were, not surprisingly, other tenor players, a situation leading to the dreaded “musician’s musician” tag. But that’s not nearly praise enough to describe Chu Berry, who, when given opportunity, displayed a musical dexterity that would be envied by future generations of horn men.

Berry faced the lot of other horn players: having to grind it out long and hard until something memorable burst through; the prejudices and expectations of the listening public; and the accepted wisdom of what is and isn’t art in a given medium. In this case, swing was fodder for dance parties, not music worthy of study.

Oddly enough, Berry’s geniality might help explain his failure to court history’s favor: it wasn’t in his nature to call attention to himself or his playing. Born in 1908 into the black middle class in Wheeling, West Virginia, the laid-back, affable Berry attended West Virginia State in Charleston, where he switched from alto sax to tenor and exhibited the willingness to fit in that characterized his presence in so many dance bands. He was the rare artist who refused to put his interests above those of the band, even if that meant playing ensemble passages rather than taking a healthy allotment of solo breaks.

College proved a training ground for Berry the bandsman, as he teamed up with a number of amateur outfits. He never played simply to show off. Instead, he tried to bring out the positive attributes in any given situation or setting. Later, when Berry is performing with the Calloway ensemble, we hear some ragged, out-of-tune playing until Berry’s first few solo notes emerge.

The other players, no longer languidly blowing through their charts, immediately surge up behind him, all fighting-fit. Once Berry finishes his solo, the shenanigans resume.

After making his way to New York, Berry immediately became a presence and soon was in demand. The great jazz orchestras of the swing era were fronted by musical directors/arrangers—Duke Ellington was pre-eminent—who drew the acclaim. The sidemen were musical traveling salesmen who sold someone else’s wares in the best style they could manage. It was with Fletcher Henderson that Berry began to ditch some of the sideman’s subservient trappings. For starters, Henderson wrote in keys that were rare for the jazz orchestras of the day, and his somber, indigo-inflected voicings were ideal for a player of Berry’s introspective approach to his instrument: Berry sounds as if he’s being swallowed by his sax. “Blues in C Sharp Minor,” for instance, is odd, haunting, and ultimately relaxing. A Berry solo in it is slightly off mike, making the listener feel as though he’s been playing for some time before we finally hear him. The effect is unnerving, as if we weren’t paying close attention.

In June 1940, Cab Calloway granted Berry a showcase piece, “A Ghost of a Chance,” the sole recording in Berry’s career to feature him from start to finish. It was his “Body and Soul,” a response to Coleman Hawkins’s famous recording, intended not as a riposte to a rival, but as the other half of a dialogue. Its rubato lines are disembodied from the music meant to accompany it, which is spartan to begin with. This may be Berry’s one and only instance of indulgence on a record, a cathedral of a solo in its flourishes, angles, ornamentations, reflexivity. If sunlight could pass through music, “A Ghost of a Chance” would funnel it out in the broadest spectrum of colors.

21. Based on the passage, how did Berry’s personality affect his career?
- A. His ambitious, competitive personality was off-putting to other musicians, who were reluctant to play with him.
 - B. His genial personality endeared him to other musicians, but his career suffered when he spent more time socializing than practicing.
 - C. His modest and easygoing personality kept him out of the spotlight and, consequently, he received less attention as a performer.
 - D. His shy, introspective personality was misunderstood as snobbish arrogance, so he was offered few recording-session jobs.

22. The author mentions Berry's solo in "Oh, Lady Be Good" primarily in order to:
- F. illustrate why most people haven't heard of Berry.
 - G. provide an example of Berry's musical excellence.
 - H. contrast Berry's later work with Berry's early work.
 - J. establish that Berry's solo was better than Count Basie's.
23. The author points out that many serious jazz enthusiasts know little about Berry primarily in order to:
- A. criticize scholarship that has provided an unbalanced history of jazz.
 - B. demonstrate that the author is more knowledgeable than most jazz scholars.
 - C. illustrate the secrecy Berry demanded in order to preserve his family's privacy.
 - D. explain why it's likely that readers would be unfamiliar with Berry.
24. According to the author, Berry's solos as a recording-session musician were often very short because he:
- F. wasn't a very good saxophone player until late in his career.
 - G. drew more attention playing ensemble passages.
 - H. worked within the recording constraints of the era.
 - J. preferred playing many short solos to playing a few long ones.
25. The author indicates that during Berry's time as a musician, swing music was primarily regarded as:
- A. an opportunity for soloists to show off their skills.
 - B. a genre to be most appreciated by young people.
 - C. musician's music that lacked a popular audience.
 - D. music for dance parties but not music for study.
26. As it is used in line 35, the word *court* most nearly means to:
- F. seek to attract.
 - G. romantically pursue.
 - H. dangerously provoke.
 - J. pass judgment upon.
27. In the seventh paragraph (lines 57–75), the author compares sidemen to traveling salesmen in order to:
- A. make clear how often musicians had to travel.
 - B. indicate that musicians often had side jobs.
 - C. illustrate sidemen's supportive role in a band.
 - D. show how hard sidemen worked to get hired.
28. The author describes Henderson's "Blues in C Sharp Minor" as:
- F. innovative, indulgent, and colorful.
 - G. fast-moving, memorable, and eerie.
 - H. artful, sublime, and unexpectedly upbeat.
 - J. odd, haunting, and relaxing.
29. According to the author, what is unique about the June 1940 rendition of the song "A Ghost of a Chance"?
- A. It's the only recorded piece that features Berry from beginning to end.
 - B. Berry plays an alto saxophone instead of his usual tenor saxophone.
 - C. It was the only public performance Berry gave in 1940.
 - D. Berry showcases his unrivaled ability to play a solo that blends into the background.
30. The author uses the phrase "a cathedral of a solo" (line 85) most likely to create a sense that Berry's solo was:
- F. an intricate, awe-inspiring masterpiece.
 - G. a somber, mournful hymn.
 - H. a crumbling remnant of Berry's once-great skill.
 - J. a testament to Calloway's band leadership.

Passage IV

NATURAL SCIENCE: This passage is adapted from the article “Warp Factor” by Charles Liu (©2003 by Natural History Magazine, Inc.).

Astronomers sometimes describe the shape of our home galaxy, the Milky Way, as a thin-crust pizza with a plum stuck in the middle. The plum is the slightly oblong central bulge, protruding about 3,000 light-years above and below the galactic plane, comprised mostly of older stars; it makes up the core of the Milky Way, and includes a black hole two and a half million times the mass of the Sun. The crust of the pizza is the galactic disk—the source of most of our galaxy’s light. Thin and flat, the disk is 100,000 light-years across, about 1,000 light-years thick, on average, and includes more than 80 percent of the galaxy’s hundred billion or so stars.

The plum-and-pizza picture works well enough, but like most simple metaphors, it breaks down if you push it. For one thing, the galactic disk isn’t a rigid body, but a loose agglomeration of matter streaming around a common center of gravity. (The swirling pattern of a hurricane far better resembles our spinning galaxy.) For another thing, our galaxy’s disk isn’t flat; it’s warped. Picture a disk of pizza dough spun into the air by a skilled chef: our galaxy goes through the same kind of floppy, wobbly gyrations, though at a rate best measured in revolutions per hundreds of millions of years.

Why does the Milky Way have such an odd-looking warp? No definitive answer has emerged. One thing we do know: when it comes to warps, our galaxy is hardly unique. About half of all spiral galaxies are warped to some degree. Theoretical and computational models have shown that a number of physical processes can warp a galaxy, so it’s a matter of figuring out which scenario applies. An innovative analysis of the problem by Jeremy Bailin, an astronomy graduate student at the University of Arizona in Tucson, has implicated a small satellite galaxy, currently being ripped to shreds by the gravity of the Milky Way.

The Sagittarius Dwarf Spheroidal Galaxy was discovered in 1994. It appears to be in a roughly polar orbit around the Milky Way—that is, above and below the galactic disk—about 50,000 light-years from the galactic center. That orbit brings the dwarf galaxy far too close to the huge gravitational tidal forces of the Milky Way for the dwarf to remain intact. As a result, the Sagittarius Dwarf now looks something like strands of spaghetti spilling from the front of a pasta-making machine, the galaxy’s matter being drawn out over hundreds of millions of years by intergalactic tides.

Gravitational collisions between small satellite galaxies and big spiral galaxies have long been regarded as possible culprits in the warping of a larger galaxy’s disk. The best known satellite galaxies orbiting the Milky Way—the Large and Small Magellanic Clouds—are too far away, and have the wrong orbital

characteristics, to have warped our galactic home. The Sagittarius Dwarf seems a much more likely candidate, simply because it is only a third as far from the center of the Milky Way as the Magellanic Clouds. But in astronomy—unlike in real estate—location isn’t everything; to show a direct connection between warp and dwarf, the orbital motion of the Sagittarius Dwarf must be linked to the rotation of the Milky Way’s disk.

Bailin’s study is the first to find such a link. His analysis of the galactic warp is based on angular momentum—a measure of how much a system is spinning or rotating. Just as objects moving in a straight line have momentum, objects spinning or orbiting around an axis have angular momentum; and just as the momenta of two objects combine when they collide, so too do their angular momenta. Imagine two figure skaters coming together for a combination spin. When they make physical contact, their individual spiraling motions combine to produce a single, unified whirl.

Starting with the latest measurements of the structure and spin of the Milky Way, Bailin deduced the angular momentum of the warped portion of the Milky Way’s disk. He then compared that measure with the angular momentum of the Sagittarius Dwarf—and found for the first time, within the margins of measurement error, that the two angular momenta are identical in both quantity and direction. Such a coupling of the angular momenta of two bodies almost never happens by chance; usually, it takes place only when two spinning systems, like the skaters, come into contact. The coupling isn’t enough to prove cause and effect by itself, but it’s solid circumstantial evidence that the interaction of the Sagittarius Dwarf with the Milky Way disk created the warp in our galaxy.

31. Which of the following statements best expresses the main idea of the passage?
- A. Bailin began studying the Sagittarius Dwarf when he was a graduate student in astronomy.
 - B. The gravitational tidal forces of the Milky Way are destroying the Sagittarius Dwarf.
 - C. Most astronomers have come to an agreement that evidence about how galaxies have formed is, at best, circumstantial.
 - D. Evidence suggests that the warp in the Milky Way’s disk results from the Milky Way’s interaction with a small satellite galaxy.
32. It can reasonably be inferred that the problem the author mentions in line 33 refers to:
- F. a particular aspect of Bailin’s theory for which there is little evidence.
 - G. a mathematical computation that led Bailin to focus on the Sagittarius Dwarf.
 - H. the question of which physical processes caused the warp in the Milky Way.
 - J. the potential impact of wobbly gyrations on the Milky Way’s rotation.

33. It can reasonably be inferred from the passage that the small satellite galaxy referred to in lines 35–36 is:
- A. the Small Magellanic Cloud.
 - B. the Sagittarius Dwarf.
 - C. a known but as yet unnamed galaxy.
 - D. a hypothetical galaxy that is believed to exist but has not yet been found.
34. Based on the passage, which of the following statements best describes Bailin’s study as it relates to the field of astronomy?
- F. It led astronomers to the discovery of a warp in the Milky Way’s disk.
 - G. It convinced more astronomers to focus their attention on the center of the Milky Way.
 - H. It revealed problems with the basic assumptions held by most astronomers.
 - J. It provided evidence for an idea that scientists had long considered a possibility but had not yet proved.
35. According to the passage, Bailin discovered that the angular momentum of the warped portion of the Milky Way and the angular momentum of the Sagittarius Dwarf are:
- A. identical in quantity but different in direction.
 - B. identical in direction but different in quantity.
 - C. identical in both quantity and direction.
 - D. different in both quantity and direction.
36. According to the passage, the central bulge of the Milky Way is comprised of:
- F. 80 percent of the galaxy’s stars.
 - G. older stars and a black hole.
 - H. a galactic plane and several dwarf planets.
 - J. a loose agglomeration of unidentified matter.
37. The author refers to the swirling pattern of a hurricane primarily in order to:
- A. help explain the shortcomings of the plum-and-pizza metaphor.
 - B. argue that the unpredictability of the rotation of spiral galaxies requires a new metaphor.
 - C. emphasize the particular aspects of the Milky Way that make it unique.
 - D. describe how the movement of the Milky Way creates gravitational tides.
38. The passage directly compares the Milky Way’s disk as it is affected by its warp to:
- F. a pasta maker churning out spaghetti.
 - G. pizza dough being spun in the air by a chef.
 - H. a thin-crust pizza balanced on top of a plum.
 - J. two figure skaters coming together for a combination spin.
39. According to the passage, which of the following statements best describes the movement of the Sagittarius Dwarf with respect to the Milky Way?
- A. It appears to be in a roughly polar orbit around the Milky Way.
 - B. It appears to orbit the Milky Way at an angle of roughly forty-five degrees.
 - C. It follows the movement of the stars in the Milky Way’s disk, though at a slightly faster rate.
 - D. It once followed the movement of the stars in the Milky Way’s disk, but now seems to move erratically along its own path.
40. The passage describes angular momentum as the amount of a system’s:
- F. vertical deviation within an orbital path.
 - G. movement in a straight line through space.
 - H. gravitational pull.
 - J. spin or rotation.

END OF TEST 3

STOP! DO NOT TURN THE PAGE UNTIL TOLD TO DO SO.

DO NOT RETURN TO A PREVIOUS TEST.



SCIENCE TEST

35 Minutes—40 Questions

DIRECTIONS: There are several passages in this test. Each passage is followed by several questions. After reading a passage, choose the best answer to each question and fill in the corresponding oval on your answer document. You may refer to the passages as often as necessary.

You are NOT permitted to use a calculator on this test.

Passage I

A study was conducted to examine whether female *Blattella germanica* (a species of cockroach) prefer to eat cat food, cheese, ham, or peanuts. First, 200 mg of each of the 4 foods was separately placed into a single box. Then, adult female *B. germanica* were added to the box. Figure 1 shows how the mass, in mg, of each food in the box changed over time after the addition of the *B. germanica*. Table 1 shows the percent by mass of carbohydrates, lipids, proteins, and water, respectively, present in each of the 4 foods tested in the study.

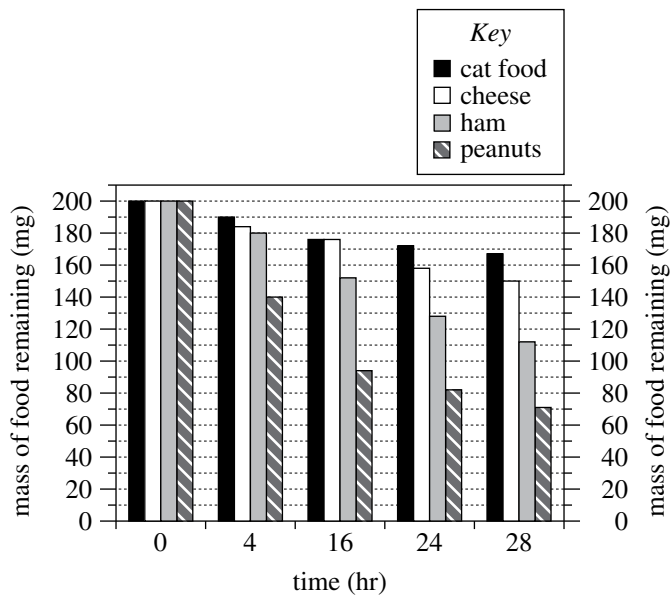

Figure 1

Figure adapted from Prachumporn Lauprasert et al., "Food Preference and Feeding Behavior of the German Cockroach, *Blattella germanica* (Linnaeus)." ©2006 by the Faculty of Science, Chulalongkorn University.

Food	Percent by mass			
	carbohydrates	lipids	proteins	water
Cat food	1.2	6.0	16.9	66.2
Cheese	0.5	27.7	20.8	48.4
Ham	0.0	18.2	23.6	57.1
Peanuts	15.8	49.6	26.2	6.4

Table adapted from U.S. Department of Agriculture, *USDA National Nutrient Database for Standard Reference, Release 24*. 2011.

- According to Figure 1, the mass of cheese remaining at 4 hr was closest to which of the following values?
 - 140 mg
 - 176 mg
 - 185 mg
 - 190 mg
- Suppose a company wants to use food as bait in a trap designed to capture female *B. germanica*. Based on Figure 1, which of the 4 foods should the company place in the trap to maximize the chance of capturing female *B. germanica*?
 - Cat food
 - Cheese
 - Ham
 - Peanuts

4**4**

3. Consider the 4 foods in order of the percent by mass of proteins, from lowest to highest. From food to food, as the percent by mass of proteins increased, the mass of food remaining at 28 hr:
- A. increased only.
 - B. decreased only.
 - C. increased and then decreased.
 - D. decreased and then increased.
4. Consider the statement “The *B. germanica* ate the food between 0 hr and 4 hr, between 4 hr and 16 hr, between 16 hr and 24 hr, and between 24 hr and 28 hr.” This statement is consistent with the data in Figure 1 for how many of the 4 foods?
- F. 1
 - G. 2
 - H. 3
 - J. 4
5. A student predicted that the *B. germanica* would eat less cat food than ham by the end of the study. Do the data in Figure 1 support this prediction?
- A. Yes; at 28 hr, the mass of cat food remaining was about 55 mg greater than the mass of ham remaining.
 - B. Yes; at 28 hr, the mass of cat food remaining was about 95 mg greater than the mass of ham remaining.
 - C. No; at 28 hr, the mass of cat food remaining was about 55 mg less than the mass of ham remaining.
 - D. No; at 28 hr, the mass of cat food remaining was about 95 mg less than the mass of ham remaining.
6. Based on Table 1, when 200 mg of each of the 4 foods was placed in the box, water accounted for more than 100 mg of the mass of which food(s)?
- F. Peanuts only
 - G. Cat food and ham only
 - H. Cheese and peanuts only
 - J. Cat food, cheese, and ham only

**Passage II**

A teacher provided the table below to the students in a science class. The table gives 5 properties for each of Samples A–H. The students were told to assume that each sample is a completely solid cube composed of a single hypothetical pure substance.

Sample	Mass (g)	Volume (cm ³)	Density (g/cm ³)	Melting point (°C)	Boiling point (°C)
A	8.0	4.0	2.0	126	747
B	8.0	4.0	2.0	342	959
C	6.0	3.0	2.0	237	885
D	6.0	3.0	2.0	237	885
E	8.0	2.0	4.0	126	747
F	8.0	2.0	4.0	126	747
G	4.0	1.0	4.0	126	747
H	4.0	1.0	4.0	342	959

Note: Assume that mass, volume, and density were determined at 20°C and that all 5 properties were determined at 1 atmosphere (atm) of pressure.

The teacher asked each of 4 students to explain how these data could be used to predict which samples are composed of the same substance.

Student 1

If 2 samples have the same values for all 5 properties, they are composed of the same substance. If 2 samples have different values for any of the 5 properties, they are composed of different substances.

Student 2

If 2 samples have the same values for any 3 or more of the 5 properties, they are composed of the same substance. If 2 samples have the same values for fewer than 3 of the 5 properties, they are composed of different substances.

Student 3

If 2 samples have the same mass, volume, and density, they are composed of the same substance. If 2 samples have different values for any of these 3 properties, they are composed of different substances. Neither melting point nor boiling point, by itself, can distinguish between substances.

Student 4

If 2 samples have the same density, melting point, and boiling point, they are composed of the same substance. If 2 samples have different values for any of these 3 properties, they are composed of different substances. Neither mass nor volume, by itself, can distinguish between substances.

7. Based on Student 1's explanation, the same substance composes both of the samples in which of the following pairs?
- A. Samples A and B
 - B. Samples B and C
 - C. Samples C and D
 - D. Samples D and E



8. Based on Student 3's explanation, the same substance composes both of the samples in which of the following pairs?
- F. Samples A and C
 - G. Samples B and E
 - H. Samples F and G
 - J. Samples G and H
9. Suppose that the temperature of Sample A is increased to 250°C at 1 atm of pressure. At 250°C, would Sample A be a solid or a liquid?
- A. Solid, because the melting point of Sample A is 126°C.
 - B. Solid, because the melting point of Sample A is 747°C.
 - C. Liquid, because the melting point of Sample A is 126°C.
 - D. Liquid, because the melting point of Sample A is 747°C.
10. Consider the claim that 2 samples having the same density will always be composed of the same substance, regardless of the values of the other 4 properties. Which of the students, if any, would be likely to agree with this claim?
- F. Students 1 and 2 only
 - G. Students 2, 3, and 4 only
 - H. All of the students
 - J. None of the students
11. Which of Students 2, 3, and 4 would be likely to agree that Sample A and Sample B are composed of the same substance?
- A. Students 2 and 3 only
 - B. Students 2 and 4 only
 - C. Students 3 and 4 only
 - D. Students 2, 3, and 4
12. Consider the statement "Two samples that have the same mass, volume, density, and boiling point are composed of the same substance, even if the two samples have different melting points." Which of Students 2 and 4, if either, would be likely to agree with this statement?
- F. Student 2 only
 - G. Student 4 only
 - H. Both Student 2 and Student 4
 - J. Neither Student 2 nor Student 4
13. Suppose that the temperature of Sample D is increased to 890°C at 1 atm of pressure. Will the sample's density be lower than or higher than it was at 20°C and 1 atm?
- A. Lower; Sample D will be a gas, and gases generally have lower densities than do solids.
 - B. Lower; Sample D will be a liquid, and liquids generally have lower densities than do solids.
 - C. Higher; Sample D will be a gas, and gases generally have higher densities than do solids.
 - D. Higher; Sample D will be a liquid, and liquids generally have higher densities than do solids.

**Passage III**

When a solid metal (M) such as iron (Fe), nickel (Ni), or zinc (Zn) is placed in an aqueous hydrochloric acid (HCl) solution, a reaction that produces H_2 gas occurs:

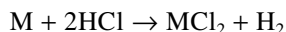

Two experiments were conducted to study the production of H_2 in this reaction. The apparatus shown in the diagram below was used to collect the H_2 gas produced in each trial.

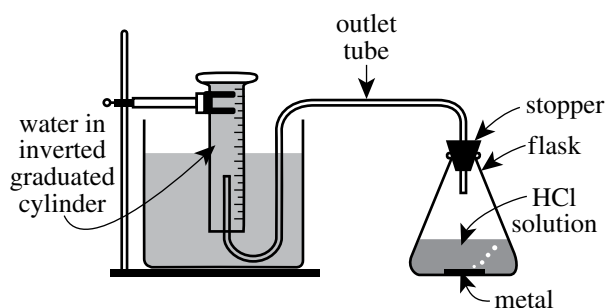

diagram

As H_2 was produced in the stoppered flask, it exited the flask through the outlet tube and displaced the water that had been trapped in the inverted graduated cylinder. (This displacement occurred because the H_2 did not dissolve in the water.) The volume of water displaced equaled the volume of gas (H_2 and water vapor) collected.

In each trial of the experiments, Steps 1–3 were performed:

1. The apparatus was assembled, and 25 mL of a 4 moles/L HCl solution was poured into the empty flask.
2. A selected mass of Fe, Ni, or Zn was added to the flask, and the stopper was quickly reinserted into the flask.
3. When H_2 production ceased, the volume of water that was displaced from the graduated cylinder was recorded.

The apparatus and its contents were kept at a selected temperature throughout Steps 2 and 3. The atmospheric pressure was 758 mm Hg throughout all 3 steps.

Experiment 1

In each trial, a selected mass of Fe, Ni, or Zn was tested at $30^\circ C$ (see Figure 1).

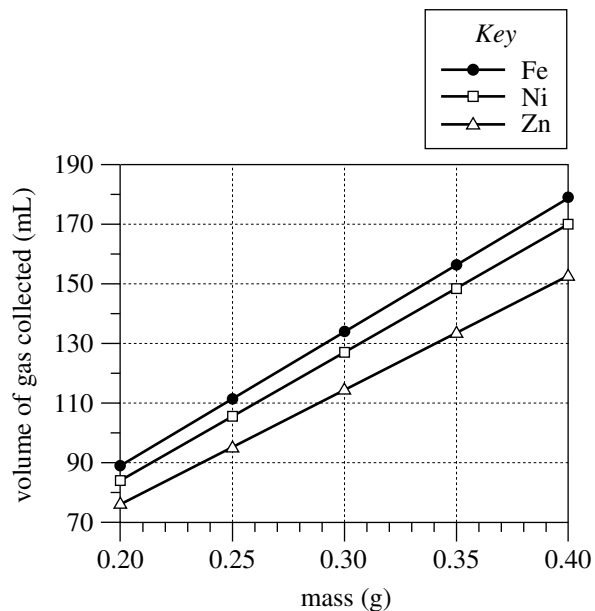

Figure 1

Experiment 2

In each trial, 0.30 g of Fe, Ni, or Zn was tested at a selected temperature (see Figure 2).

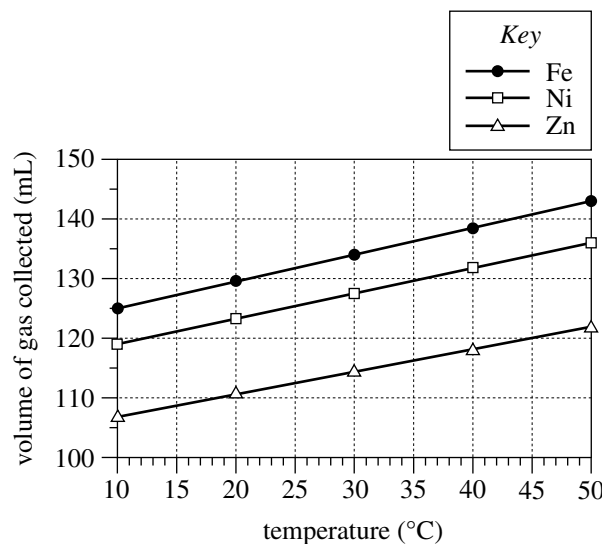

Figure 2



14. Consider the volume of gas collected in the trial in Experiment 2 for Ni at 30°C. The same approximate volume of gas was collected in the trial in Experiment 1 for what mass of Ni ?
- F. 0.20 g
G. 0.25 g
H. 0.30 g
J. 0.35 g
15. How many temperatures were tested in Experiment 1, and how many temperatures were tested in Experiment 2 ?
- | | Experiment 1 | Experiment 2 |
|----|--------------|--------------|
| A. | 1 | 1 |
| B. | 1 | 5 |
| C. | 5 | 1 |
| D. | 5 | 5 |
16. Which of the following statements describes a difference between Experiments 1 and 2 ? In Experiment 1:
- F. only Fe was tested, but in Experiment 2, Fe, Ni, and Zn were tested.
G. Fe, Ni, and Zn were tested, but in Experiment 2, only Fe was tested.
H. the same mass value of each metal was tested, but in Experiment 2, multiple mass values of each metal were tested.
J. multiple mass values of each metal were tested, but in Experiment 2, the same mass value of each metal was tested.
17. Which of the following variables remained constant throughout both experiments?
- A. Atmospheric pressure
B. Mass of metal
C. Temperature
D. Volume of gas collected
18. If a temperature of 5°C had been tested in Experiment 2, would the volume of gas collected for Zn more likely have been greater than 107 mL or less than 107 mL ?
- F. Greater than 107 mL, because for a given metal, the volume of collected gas increased as the temperature decreased.
G. Greater than 107 mL, because for a given metal, the volume of collected gas increased as the temperature increased.
H. Less than 107 mL, because for a given metal, the volume of collected gas decreased as the temperature decreased.
J. Less than 107 mL, because for a given metal, the volume of collected gas decreased as the temperature increased.
19. Consider the balanced chemical equation in the passage. Based on this equation, if 10 moles of HCl are consumed, how many moles of H₂ are produced?
- A. 5
B. 10
C. 15
D. 20
20. Suppose that the trial in Experiment 1 with 0.25 g of Zn is repeated, except that the inverted graduated cylinder is replaced by inverted test tubes, each completely filled with 60 mL of water. Based on Figure 1, how many test tubes will be needed to collect all the gas?
- F. 1
G. 2
H. 3
J. 4

**Passage IV**

Figure 1 is a diagram of an *RLC circuit*. The circuit has a power supply and 3 components: a resistor (R), an inductor (L), and a capacitor (C).

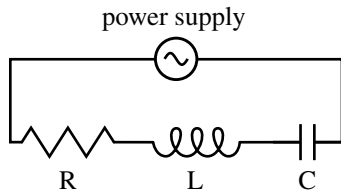

Figure 1

Electric current can flow through the circuit either clockwise (positive current) or counterclockwise (negative current). Figure 2 shows how the electric current in the circuit, I (in amperes, A), and the power supply voltage, V_S (in volts, V), both changed during a 20-millisecond (msec) time interval.

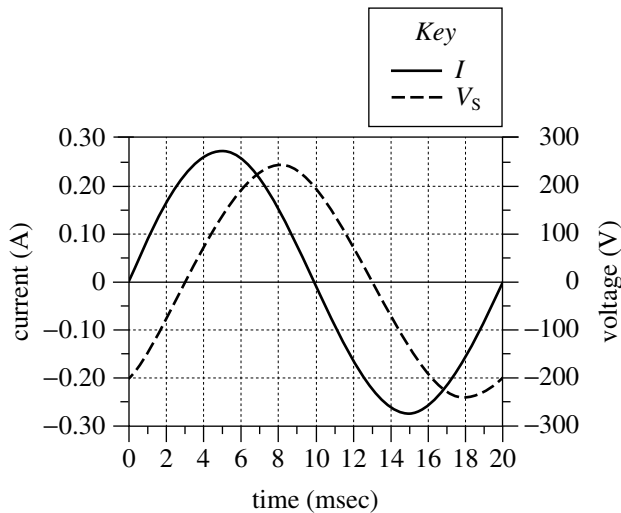

Figure 2

Figure 3 shows how the voltages across the components— V_R , V_L , and V_C , respectively—each changed during the same 20 msec time interval.

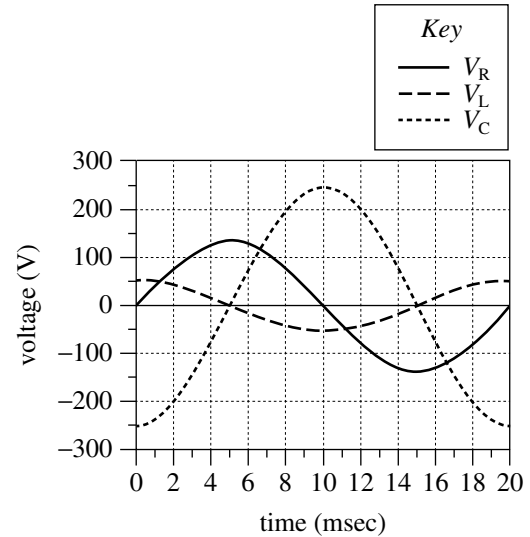

Figure 3

21. According to Figure 2, the maximum positive value of V_S was approximately:
- 125 V.
 - 200 V.
 - 250 V.
 - 275 V.
22. A *period* is the time required for a wave to complete one full cycle. Based on Figure 3, the period for V_L was:
- 5 msec.
 - 10 msec.
 - 20 msec.
 - 40 msec.



23. According to Figures 2 and 3, which voltage varied the *least* during the 20 msec interval?
- V_S
 - V_R
 - V_L
 - V_C
24. *Polarity* refers to whether a voltage is positive or negative (a voltage of 0 V has no polarity and can be ignored). Based on Figures 2 and 3, which 2 voltages were always *opposite* in polarity?
- V_R and V_L
 - V_R and V_S
 - V_L and V_C
 - V_L and V_S
25. Based on Figure 2, at which of the following times was the current in the circuit flowing counterclockwise?
- 0 msec
 - 5 msec
 - 10 msec
 - 15 msec
26. The table below lists the electric charge (in microcoulombs, μC) stored on the capacitor at 3 different times during the 20 msec interval.

Time (msec)	Charge (μC)
7	0.51
10	0.87
13	0.51

Based on Figures 2 and 3, from time = 7 msec through time = 13 msec, did the charge on the capacitor more likely change in sync with I or with V_C ?

- I ; over that time interval, both the charge and I decreased and then increased.
- I ; over that time interval, both the charge and I increased and then decreased.
- V_C ; over that time interval, both the charge and V_C decreased and then increased.
- V_C ; over that time interval, both the charge and V_C increased and then decreased.

**Passage V**

Strains of bacteria carrying a genetic mutation that prevents them from synthesizing the amino acid *histidine* are called *His⁻*. These strains of bacteria must absorb histidine from their environment in order to sustain their growth. Exposing *His⁻* strains of bacteria to *mutagens* (substances that induce DNA mutations) can cause new mutations that restore the ability of some bacteria to synthesize histidine. Any bacterium that regains the ability to synthesize histidine becomes *His⁺* and is known as a *His⁺ revertant*.

The number of *His⁺* revertants in a population of bacteria can indicate the potential of a substance to be mutagenic in humans. Scientists tested 4 substances, each suspected to be a mutagen, on a *His⁻* strain of the bacteria *Salmonella typhimurium*.

Study

A sterile petri dish (Dish 1) containing a nutrient agar lacking histidine was prepared. Then, 1×10^8 cells of *His⁻ S. typhimurium* were added to Dish 1 and evenly spread over the surface of the nutrient agar. These procedures were repeated for 4 more nutrient agar dishes (Dishes 2–5), except that the bacteria were mixed with 1 of the 4 suspected mutagens before being spread over the surface of the nutrient agar. Table 1 lists, for each of Dishes 2–5, the substance that was mixed with the bacteria before they were added to the dish.

Dish	Substance
2	L
3	M
4	N
5	P

The 5 dishes were incubated at 37°C for 2 days. At the end of the incubation period, the number of colonies growing on the nutrient agar in each dish was determined (see Table 2).

Dish	Number of colonies
1	2
2	14
3	25
4	107
5	6

27. Based on the results of the study, which of the suspected mutagens resulted in the greatest number of *His⁺* revertants in a dish?
- A. Substance L
 B. Substance M
 C. Substance N
 D. Substance P
28. Which dish in the study was intended to serve the purpose of testing whether some of the *S. typhimurium* cells became *His⁺* revertants without the addition of a mutagen?
- F. Dish 1
 G. Dish 2
 H. Dish 3
 J. Dish 4



29. Based on the results of the study, what is the order of the suspected mutagens, from the substance with the *least* potential to be mutagenic to the substance with the *most* potential to be mutagenic?
- A. P, M, N, L
 - B. P, L, M, N
 - C. N, L, P, M
 - D. N, M, L, P

30. In the study, the scientists tested the effect of Substance P at a concentration of 5×10^{-9} g/mL. After the study, the scientists repeated their test of the effect of Substance P, but at 3 other concentrations. The 3 concentrations and their corresponding results are shown in the table below.

Concentration of Substance P	Number of colonies
10×10^{-9} g/mL	14
50×10^{-9} g/mL	54
100×10^{-9} g/mL	114

What is the relationship, if any, between the concentration of Substance P and its potential to cause mutations?

- F. As the concentration of Substance P increases, its potential to cause mutations increases only.
 - G. As the concentration of Substance P increases, its potential to cause mutations decreases only.
 - H. As the concentration of Substance P increases, its potential to cause mutations first decreases and then increases.
 - J. There is no relationship between the concentration of Substance P and its potential to cause mutations.
31. Before bacteria were added to it, the dish that was intended to serve as the control dish in the study lacked which of the substances listed below?
- I. Histidine
 - II. Nutrient agar
 - III. Suspected mutagen
- A. II only
 - B. III only
 - C. I and II only
 - D. I and III only
32. Which of the following statements about the numbers of bacteria that regained the ability to synthesize histidine is consistent with the results of the study for Dishes 2 and 3? The number of bacteria that became His⁺ revertants after exposure to:
- F. Substance M was about 2 times the number of bacteria that became His⁺ revertants after exposure to Substance L.
 - G. Substance L was about 2 times the number of bacteria that became His⁺ revertants after exposure to Substance M.
 - H. Substance M was about 4 times the number of bacteria that became His⁺ revertants after exposure to Substance L.
 - J. Substance L was about 4 times the number of bacteria that became His⁺ revertants after exposure to Substance M.
33. The particular strain of *S. typhimurium* chosen for the study lacks normal DNA repair mechanisms. Which of the following statements gives the most likely reason this particular strain was chosen? The scientists:
- A. did not want the bacteria in the study to synthesize any DNA.
 - B. did not want the bacteria in the study to synthesize any proteins.
 - C. wanted the bacteria in the study to be able to repair the mutations caused by the substances.
 - D. wanted the bacteria in the study to be unable to repair the mutations caused by the substances.

**Passage VI**

Three studies examined how the volume of runoff from melting ice is affected by wind speed and by the presence of sand beneath the ice.

In a lab kept at 18°C, runoff was collected from a plastic box containing melting ice. The box was tilted at 10° and had horizontal openings in its lower end. After flowing through the openings, the runoff fell into a trough (see diagram) and was conveyed to a measuring device.

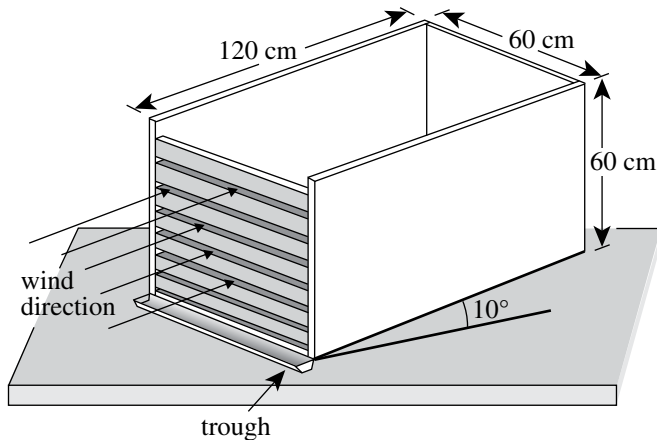

diagram of box

Study 1

In each of the first 3 of 4 trials, the following steps were carried out:

1. A 30 cm deep layer of a particular clean, dry sand was placed in the box.
2. A 30 cm deep layer of *chipped ice* (density 0.4 g/cm³) was placed in the box on top of the layer of sand.
3. A fan was turned on to blow air at a constant speed onto the trough end of the box.
4. For the next 600 min, the volume of runoff collected over each 20 min period was measured.

The wind speed was 2.5 m/sec, 1.0 m/sec, and 0.5 m/sec in the first, second, and third trials, respectively.

In the fourth trial, all steps except Step 3 were carried out. (The fan was not turned on.)

The results of the 4 trials are shown in Figure 1.

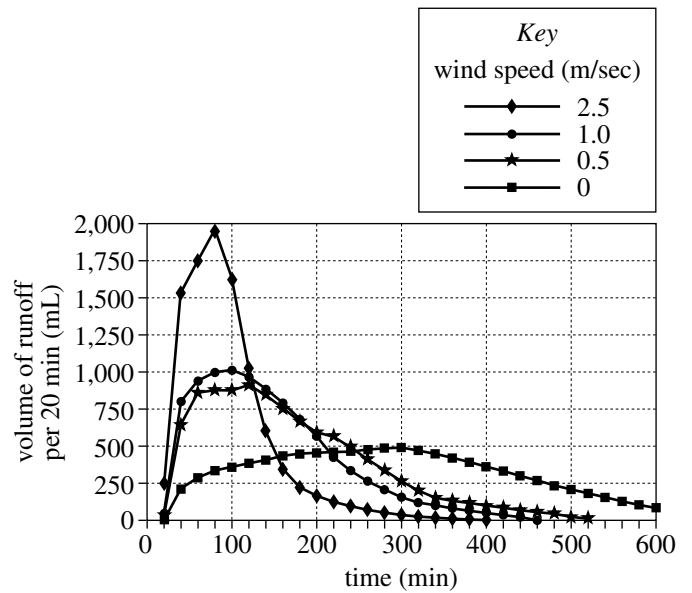

Figure 1

Study 2

The second trial of Study 1 was repeated. Then the second trial of Study 1 was again repeated, except that Step 1 was omitted. (No sand layer was placed in the box.) The results of the 2 trials are shown in Figure 2.

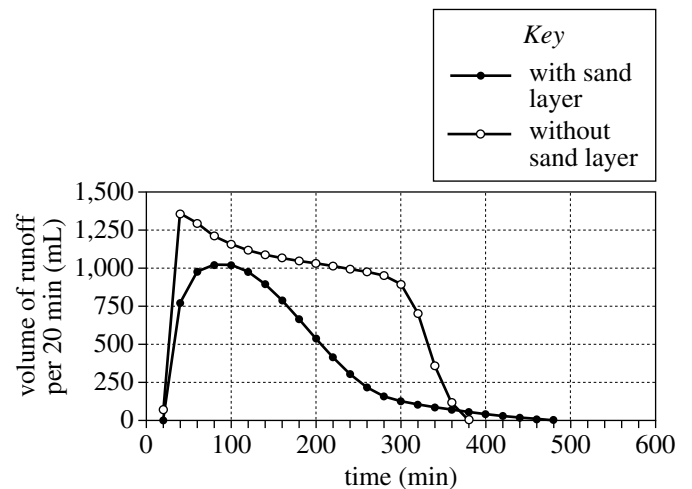
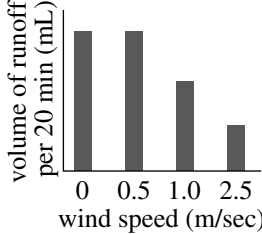
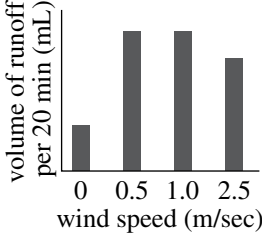
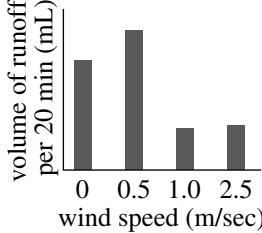
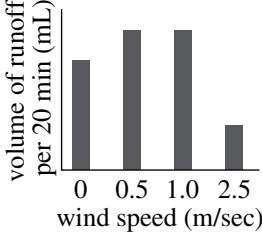

Figure 2

Figures adapted from Masahiko Hasebe and Takanori Kumekawa, "The Effect of Wind Speed on the Snowmelt Runoff Process: Laboratory Experiment." ©1994 by International Association of Hydrological Sciences Publishing.



34. The researchers conducting the studies chose to use a box made of a type of plastic rather than of wood to ensure that all of the water from the melting ice would flow from the box and into the trough. The researchers most likely made that choice because that type of plastic, unlike wood, is:
- porous and permeable, and therefore incapable of absorbing water.
 - nonporous and impermeable, and therefore incapable of absorbing water.
 - porous and permeable, and therefore capable of absorbing water.
 - nonporous and impermeable, and therefore capable of absorbing water.
35. Suppose Study 2 had been repeated, except in a lab kept at -1°C . The total volume of runoff measured over the 600 min in the repeated study would most likely have been:
- near or at zero, because -1°C is below the freezing point of water.
 - near or at zero, because -1°C is above the freezing point of water.
 - greater than that in the original study, because -1°C is below the freezing point of water.
 - greater than that in the original study, because -1°C is above the freezing point of water.
36. According to the results of Study 1, for which of the wind speeds did the runoff volume per 20 min decrease to zero from its maximum value *before* 500 min ?
- 0 m/sec only
 - 2.5 m/sec only
 - 0.5 m/sec and 1.0 m/sec only
 - 1.0 m/sec and 2.5 m/sec only
37. Compare the results of the 2 trials in Study 2. In which trial did the volume of runoff per 20 min reach a greater maximum value, and in which trial did the volume of runoff per 20 min decrease to zero from the maximum value in the shorter amount of time?
- | <u>greater maximum</u> | <u>shorter time to zero</u> |
|------------------------|-----------------------------|
| A. with sand layer | with sand layer |
| B. with sand layer | without sand layer |
| C. without sand layer | with sand layer |
| D. without sand layer | without sand layer |
38. The volume of runoff measured at 200 min in Study 1 for the 4 wind speeds is best represented by which of the following graphs?
- F. 
- H. 
- G. 
- J. 
39. Which factor was varied in Study 1 but kept the same in Study 2 ?
- Depth of sand layer
 - Wind speed
 - Tilt of box
 - Type of material that melted
40. Based on the diagram and the description of Study 1, which of the following expressions would most likely be used to calculate the *volume* of the sand layer in the plastic box (before chipped ice was placed on top)?
- $30\text{ cm} \times 60\text{ cm} \times 60\text{ cm}$
 - $30\text{ cm} \times 60\text{ cm} \times 120\text{ cm}$
 - $60\text{ cm} \times 60\text{ cm} \times 60\text{ cm}$
 - $60\text{ cm} \times 60\text{ cm} \times 120\text{ cm}$

END OF TEST 4

STOP! DO NOT RETURN TO ANY OTHER TEST.

[See Note on page 52.]

TABLE 1**Explanation of Procedures Used to Obtain Scale Scores from Raw Scores**

On each of the four multiple-choice tests on which you marked any responses, the total number of correct responses yields a raw score. Use the table below to convert your raw scores to scale scores. For each test, locate and circle your raw score or the range of raw scores that includes it in the table below. Then, read across to either outside column of the table and circle the scale score that corresponds to that raw score. As you determine your scale scores, enter them in the blanks provided on the right. The highest possible scale score for each test is 36. The lowest possible scale score for any test on which you marked any responses is 1.

Next, compute the Composite score by averaging the four scale scores. To do this, add your four scale scores and divide the sum by 4. If the resulting number ends in a fraction, round it to the nearest whole number. (Round down any fraction less than one-half; round up any fraction that is one-half or more.) Enter this number in the blank. This is your Composite score. The highest possible Composite score is 36. The lowest possible Composite score is 1.

ACT Test 1874FPRE	Your Scale Score
English	_____
Mathematics	_____
Reading	_____
Science	_____
<hr/>	
Sum of scores	_____
Composite score (sum ÷ 4)	_____

NOTE: If you left a test completely blank and marked no items, do not list a scale score for that test. If any test was completely blank, do not calculate a Composite score.

To calculate your writing score, use the rubric on pages 61–62.

Scale Score	Raw Scores				Scale Score
	Test 1 English	Test 2 Mathematics	Test 3 Reading	Test 4 Science	
36	74-75	59-60	40	40	36
35	71-73	57-58	38-39	—	35
34	70	55-56	37	39	34
33	69	54	36	38	33
32	68	53	34-35	—	32
31	67	51-52	33	37	31
30	66	49-50	32	36	30
29	64-65	47-48	31	—	29
28	63	45-46	30	35	28
27	61-62	42-44	—	34	27
26	59-60	39-41	29	32-33	26
25	56-58	37-38	28	31	25
24	53-55	34-36	26-27	29-30	24
23	50-52	32-33	25	26-28	23
22	47-49	31	23-24	24-25	22
21	44-46	29-30	22	22-23	21
20	41-43	27-28	20-21	20-21	20
19	39-40	25-26	19	18-19	19
18	37-38	22-24	18	17	18
17	35-36	19-21	16-17	15-16	17
16	32-34	16-18	15	14	16
15	29-31	13-15	14	13	15
14	26-28	10-12	12-13	11-12	14
13	24-25	8-9	11	10	13
12	22-23	7	10	9	12
11	19-21	5-6	8-9	8	11
10	16-18	4	7	7	10
9	13-15	—	6	6	9
8	11-12	3	5	5	8
7	9-10	—	—	4	7
6	7-8	2	4	3	6
5	6	—	3	—	5
4	4-5	1	2	2	4
3	3	—	—	1	3
2	2	—	1	—	2
1	0-1	0	0	0	1